



**Field Reprogramming Manual
MODEL V900 / H900
PIO9, MPC-P8, & MPC-P8-2
Software versions
5.xx, 1.xx.xx, 3.xx.xx
For Microprocessor-Based Traction and
Hydraulic Elevator Controls**

Product Documentation that's Simple to Navigate™

This is the Field Reprogramming Manual to be used with all Model V900 Series Traction and H900 Series Hydraulic elevator controllers. Other resources include:

- **Installation and Adjustment Manual** for Model V900 and Model H900 controllers
- **Solid State Starter Manual** for H900 controllers equipped with such starters
- **Maintenance & Troubleshooting Training Manual** provided in conjunction with factory and customer site technical training classes
- **Telephone Technical Support** available for customers at no charge
call: 800-829-8106 & 916-428-1708; fax: 916-428-1728;
e-mail: techsupport@elevatorcontrols.com
- **Onsite Product & Engineering Support** available worldwide by prior arrangement.

All information contained herein is confidential and proprietary to Elevator Controls Corporation. This document shall not be used or reproduced, in whole or part, without the prior written consent of Elevator Controls.

Publication revised 03/22/11

© 2009 Elevator Controls Corporation

Table of Contents

Introduction	Page 3
Reprogramming Using Onboard Diagnostics	
1.1 Overview	Page 4
1.2 Selecting the Elevator Status Display	Page 6
1.3 Selecting the User Display	Page 8
1.4 Changing a User Display Menu	Page 10
1.5 Changing a Direct Access Parameter	Page 11
1.6 Direct Access User Display	Page 12
1.7 Set Time Clock Parameters	Page 13
1.8 Fault Log List	Page 14
1.9 Car Timers	Page 15
1.10 Car Control	Page 16
1.11 System Timers	Page 18
1.12 System Control	Page 20
1.13 Door Options	Page 22
1.14 Fire Options	Page 24
1.15 Stopping Table	Page 25
1.16 Password Access	Page 27
1.17 Memory Flags	Page 29
1.18 Software Version	Page 33
1.19 ASME A17.1-200x Settings	Page 33
Appendix A Working with Hexadecimal Numbers	Page 34
A1 Converting Hexadecimal Numbers	Page 34
A2 Changing Hexadecimal Numbers	Page 35
Appendix B Mnemonic description reference table	Page 36

Introduction

Warnings

Throughout this manual, icons will be used to call attention to certain areas of text. These icons represent safety warnings, cautions, and notes.



WARNING: Denotes operating procedures and practices that may result in personal injury and/or equipment damage if not correctly followed.



CAUTION: Denotes operating procedures and practices that may result in equipment damage if not correctly followed.



NOTE: Denotes useful information or procedures.

Throughout this manual it is assumed that field personnel are well qualified in the installation of elevator equipment. No attempt has been made to define terms or procedures that should be familiar to a qualified elevator mechanic.



NOTE: Some of the information in this manual is pertinent only to Part # MPC-P8 and PIO9 boards with software versions 5.x, 1.xx.xx, 3.xx.xx and above dated 9/1/05 or later. The software version and date can be found by viewing the User Menu - Software Version.



NOTE: Paragraphs or table contents preceded by symbol » apply to version 1.xx.xx software version only.



NOTE: Paragraphs or table contents preceded by symbol ∞ apply to version 5.x software version only.



NOTE: The difference between version 5.x and versions 1.xx.xx and 3.xx.xx is such that version 5.x is used for simplex, duplex, and 3 or more elevator group configurations and versions 1.xx.xx and 3.xx.xx are used for 1 car group, 2 car groups and 3 or more elevator group configurations.

Reprogramming Using Onboard Diagnostics

1.1 Overview of P8 and PIO9 Microprocessor boards

The P8 Microprocessor Computer board can be used in all 900 Series standard controllers. The PIO9 Microprocessor Computer board is used on all EZ-Link2 and Prodigy controllers. The PIO9 board can also be used on all 900 Series controllers that require 24VDC fixtures only.

1.1.1 Overview of the P8

The P8 Microprocessor Computer board (MPC) pictogram appears below. Reprogramming and diagnostic controls are located on the bottom right-hand side of the P8. The liquid crystal display (LCD) is also used by the onboard diagnostics. The LCD is located at the top center of the P8 board.

P8 Microprocessor Board Layout

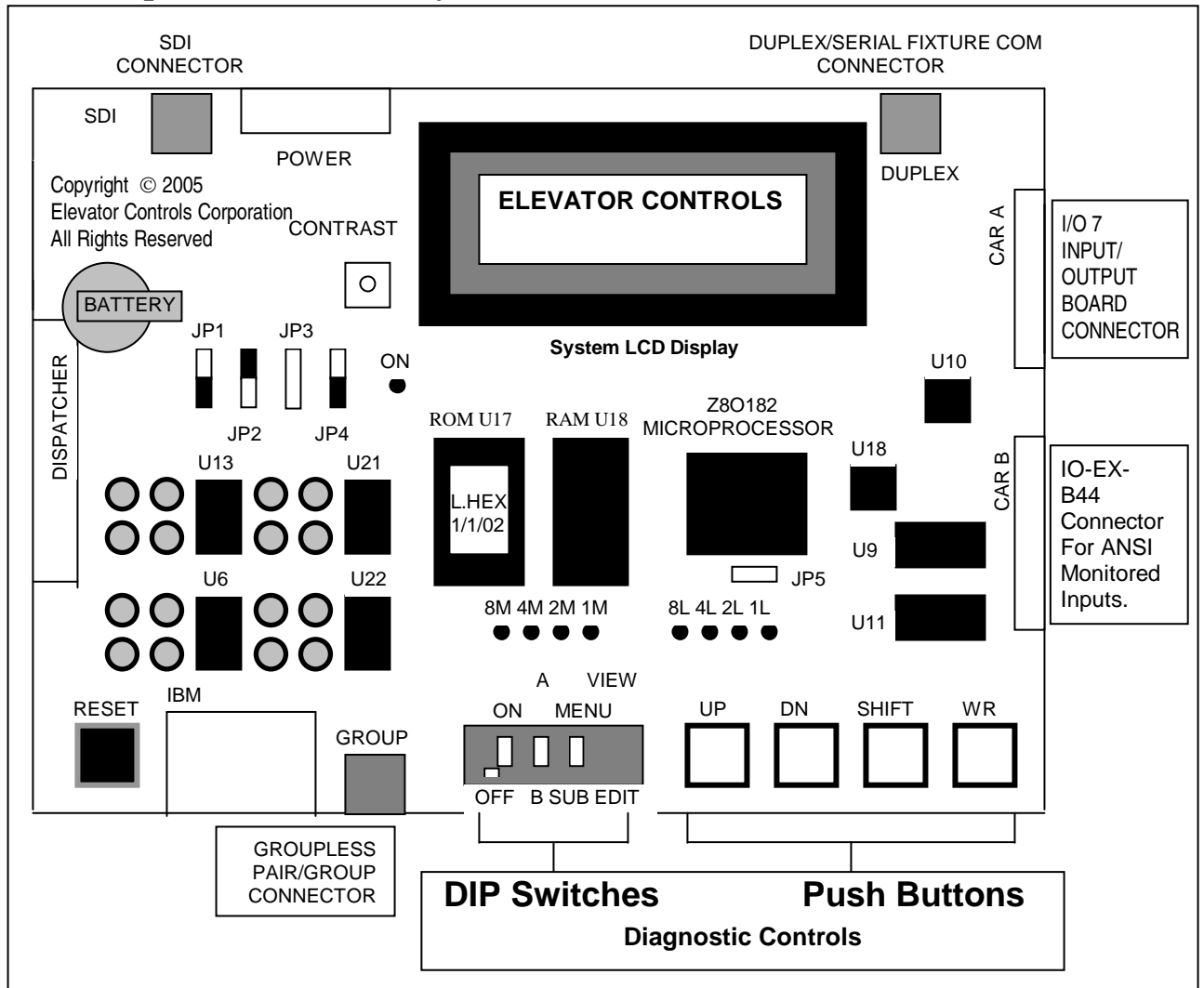

The four DIP switches and four push buttons make up the diagnostic controls. The name and function of each control is summarized in the Dip Switch & Push Button Functions table below. The buttons listed in the table from top to bottom correspond to the buttons from left to right on the P8 or PIO9 boards. The name for each button in the left column of the table corresponds to how it is labeled on the P8 or PIO9 boards. For more information about the function of each button, please refer to the sections later in this chapter.

1.1.2 Overview of the PIO9 Microprocessor Board

The PIO9 Microprocessor Computer board (PIO9) includes a replica of the P8 reprogramming and diagnostic controls tools. These are located in the center at the bottom of the PIO9 board. The LCD is located at the center of the PIO9 board.



WARNING: Do not depress the button (labeled RESET) on the P8 or PIO9 board while elevator is in operation, as it will cause the car to come to an immediate stop.

Dip Switch & Push Button Functions

Button Name	Function
ON/OFF DIP switch	Selects between elevator status and user display
A/B DIP switch	The A/B switch is irrelevant on software version 5.x. The A/B switch for software version 1.xx.xx works in conjunction with the ON/OFF switch in the OFF position, while on A it selects the Group mode of operation for the Group active dispatcher car, and while on B it selects the car normal diagnostics mode of operation, it becomes irrelevant when the ON/OFF switch is on the ON position, or for slaved cars.
MENU/SUB DIP switch	Selects menu or sub-menu display in the user display.
VIEW/EDIT DIP switch	Selects view parameter or edit (change) parameter in the user display.
UP push button	Selects the next menu or sub-menu in the user display.
DN (DOWN) push button	Selects the previous menu or sub-menu in the user display.
SHIFT push button	Selects the next parameter or digit in the edit (change) parameter mode in the user display.
WR (WRITE) push button	Saves the changed parameter permanently when in edit (change) parameter mode in the user display.

1.2 Selecting the Elevator Status Display

1.2.1 Car Status Display

Move the **ON/OFF** DIP switch to the **OFF** position and **A/B** switch to the **B** position. The Elevator Status display is now selected. The system LCD will display up to four of the following messages. The LED's display the highest priority code according to the table below:

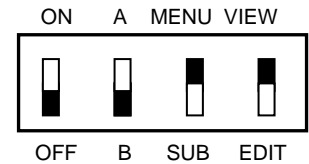

LED Error Codes

LED

Display Code	Hex Value	Description
--------------	-----------	-------------

Left-to-Right

○○○○○○●	01	USD2 and DSD2 on simultaneously
○○○○○○●○	02	Trying to step up and down at the same time
○○○○○○●●	03	Channel A cable disconnected or no I/O board
○○○○●●●	05	EEPROM write failure
○○○○●●●○	06	Controller inspection
○○○○●●●●	07	Safety string open
○○○○●○○○	08	Main Fire service phase 1
○○○○●○○●	09	Fire service phase 2
○○○○●○○○	0A	Earthquake: normal operation
○○○○●○○●	0B	Earthquake: abnormal condition
○○○○●●○○	0C	Front doors not fully closed
○○○○●●○○	0D	Rear doors not fully closed
○○○○●●○○	0E	Independent service
○○○○●●●●	0F	Out-of-service timer elapsed
○○●○○○○	10	Heavy load in car
○○●○○○○	11	DCL: Doors not closed
○○●○○○○	12	Door open limit & door lock on simultaneously
○○●○○○○	13	Starter stuck in wye or bad starter driver output
○○●○○○○	14	Car on wild operation
○○●○○○○	15	Password access active
○○●○○○○	16	Re-leveling down
○○●○○○○	17	Leveling down
○○●●○○○	18	Door reopen input active
○○●●○○○	19	Car out-of-step
○○●●○○○	1B	Brake did not lift last run
○○●●○○○	1C	Hospital service
○○●●●○○	1F	Alternate fire service phase 1
○○●○○○○	20	Drive resetting
○○●○○○○	21	Drive reset failure
○○●○○○○	22	Access inspection
○○●○○○○	23	Cartop inspection
○○●○○○○	24	In-car inspection
○○●○○○○	26	Re-leveling up
○○●○○○○	27	Leveling up
○○●○○○○	28	Emergency Power phase 1
○○●○○○○	29	Emergency Power phase 2

○●○●○●○●○	2A	Out of Service operation
○●○●○●●●	2B	Emergency Recall operation
○●○●●●○●	2E	Car-to-Lobby operation
○●○●●●●●	2F	Check channel B cable / termination (P8 board only)
○●●●○●○●	30	Test mode
○●●●○●○●	31	No P8X Comm.
○●●●○●○●	32	Viscosity operation
○●●●○●●●	33	Pit switch tripped
○●●●○●○●	34	Low oil return
○●●●○●○●	35	Emergency power pre-transfer operation
○●●●○●○●	36	Trying to relevel without direction, or both directions on
○●●●○●●●	37	In leveling zone without direction
○●●●○●○●	38	Battery lowering
○●●●●●○●	3E	Unable to close doors
○●●●●●●●	3F	Top slowdowns wired backwards
○●○●○●○●○	40	Security mode in operation
○●○●○●○●●	41	Bottom slowdowns wired backwards
○●○●○●○●○	42	Hydro pump synchronization
○●○●○●○●○	44	Motor run stall protection timer expired
○●○●○●●●○	4E	Independent and security mode
○●○●○●○●○	56	SDI out-of-service
○●○●○●○●●	57	Door Zone input error
○●○●○●○●●	59	Door zone count error
○●○●○●○●○	5A	Pump protection timer expired
○●○●○●○●●	5B	BEMT phase 1 operation
○●○●○●○●○	5C	CEMT phase 2 operation
○●○●○●○●●	5D	Hall/ car lamp fuse blown or all calls active
○●○●○●○●○	5E	Car doors bounced during takeoff
○●○●○●○●●	5F	Absolute PI correction
○●○●○●○●○	60	Bypass system fault
○●○●○●○●●	61	Door lock relays fault
○●○●○●○●○	62	Door zone relay fault
●●○●○●○●●	63	GTS relay fault
○●○●○●○●○	64	Inspection switch fault
○●○●○●○●●	65	Level relay fault
○●○●○●○●○	66	Stop relay fault
○●○●○●○●●	67	Door lock system fault
●●○●○●○●○	68	Governor contact system fault
○●○●○●○●○	69	Front door limit system fault
○●○●○●○●○	6A	Rear door limit system fault
○●○●○●○●●	6B	Contactor drop fault
○●○●○●○●○	6C	Unintended movement fault
○●○●○●○●●	6D	Car stop bypass relay fault
○●○●○●○●○	6E	ESDI safety relay fault
○●○●○●○●●	6F	Drive relay Fault
○●○●○●○●○	70	LSSM relay fault
○●○●○●○●●	71	Down relay fault
○●○●○●○●○	72	Up relay fault
●○●○ XXXX	AX	Doors unlocked (X=PI value, 1 st to 15 th)

●●●●XXXX	BX	Doors unlocked (X=PI value, 16 th to 30 th)
●●●○XXXX	CX	Same as AX above, but DLK clipped – open at high speed
●●●●XXXX	DX	Same as BX above, but DLK clipped – open at high speed
○○●●●○○○		3ARescue operation



NOTE: Error display codes below as well as Group Status Display errors are only present on software version 1.xx.xx & 3.xx.xx.

○○○○●○○●	45No Hall Comm.
○○○○●○○○	46No TOC Comm.
○○○○●●●●	47No COP front Comm.
○○○○●○○○	48No COP rear Comm.

1.2.2 Group Status Display

Move the **ON/OFF** DIP switch to the OFF position and **A/B** switch to the **A** position. The group dispatcher Elevator Status display is now selected. The system LCD will display up to four of the following messages. The LED's display the highest priority code according to the table below:

LED Error Codes

LED

Display Code	Hex Value	Description
	81	Balanced demand
	82	Up peak demand
	83	Down peak demand
	84	Lobby up peak demand
	85	Intermittent demand program

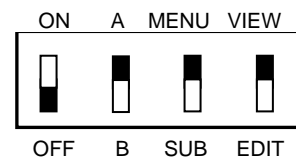

NOTE: The LED readout will indicate the highest priority code according to the Car Status Display table. There is no LED readout for Group Status Display table.

The left hand column of the table above provides the LED code for each error displayed. These codes are generally only useful to determine the fault condition with the highest priority. If more than one fault is present, the LCD messages will scroll up to four faults at a time. The Elevator Status display will also display the car position (floor number) and date and time for the elevator controller.

1.3 Selecting the User Display

To select the User Display, move the **ON/OFF** switch to the **ON** position. Move the **MENU/SUB** DIP switch to the **MENU** position. Finally, move the **VIEW/EDIT** switch to the **VIEW** position.

The User Display has twelve programming menu options from which you can select, described below. The exact function of each of the menu items is explained on the following pages. Each menu works in the same way. Use the **UP** and **DN** push buttons to select the menu item

from the list below. When the menu item you want is displayed, move the **MENU/SUB** DIP switch to the **SUB** position. The LCD will then display the sub-menu for that User Display menu.



NOTE: The A/B switch is irrelevant while diagnostics tool is used within User Display menus except for Stopping Table manipulation covered under section 1.15.

User Display Menus

Direct Access	Car Control	Fire Options
Set Clock	System Timers	Stopping Table
Fault Log	System Control	Password Access
Car Timers	Door Options	Version / Job #

User Display

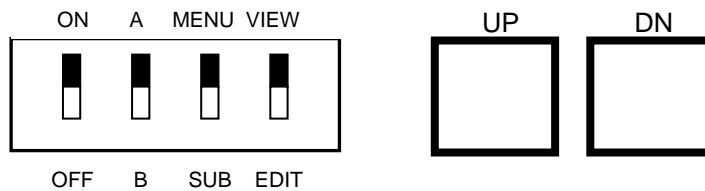

1. Set the DIP switches as shown and use the **UP** and **DN** push buttons to select the User Display menu you want.

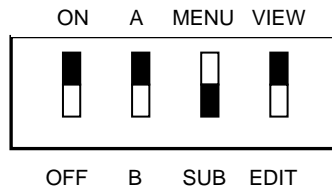

2. Then move the **MENU/SUB** DIP switch to the **SUB** position. The LCD will then show the submenu for that User Display menu.
3. Use the **UP** and **DN** push buttons to select the parameter to be viewed.

1.4 Changing a User Display Menu Parameter

Once you have selected a User Display parameter, you have the option of changing its value. For all User Display menus except Direct Access, follow this procedure.

Move the **VIEW/EDIT** DIP switch to the **EDIT** position. The bottom line of the LCD will change; 'New=XX' will appear where XX is the current value of the User Display parameter. Next, use the **UP** and **DN** push buttons to change the value. Use the **SHIFT** push button to switch to the next digit. When the value you want is displayed, press the **WR** (WRITE) push button to record the new value permanently. Return the **VIEW/EDIT** DIP switch back to the **VIEW** position.



CAUTION: Write down the value of the parameter before you begin changing it. If you make a mistake, you can always restore the old value.



WARNING: If you realize you made a mistake, **DO NOT PRESS THE WR BUTTON**. Instead, skip that step and move the **VIEW/EDIT** DIP switch to the **VIEW** position. The old value will automatically be restored.

ON A MENU VIEW



OFF B SUB EDIT

UP DN SHIFT



1. Set the DIP switches as shown to change a User Display parameter. Use the UP, DN and SHIFT push buttons to change the value of the parameter.

WR



2. Press the WR (WRITE) push button to record your changes permanently. Skip this step if you decide that you don't want to record your changes permanently.

ON A MENU VIEW



OFF B SUB EDIT

3. Move the VIEW/EDIT DIP switch back to the position shown. To select another Parameter in the selected sub-menu, use the UP and DN push buttons. To select another User Display sub-menu, start over again as on the previous page.

1.5 Changing a Direct Access Parameter

Once you have selected the Direct Access menu, you have the option of selecting an individual memory address and changing its value.

Move the **MENU/SUB** DIP switch to the **SUB** position. The bottom line of the LCD will change; 'F000=XX' will appear where XX will be the current value of the selected parameter. Next, use the **UP**, and **DN** push buttons to change the value of the memory address. Use the **SHIFT** push button to switch to the next digit. When the desired address is displayed, move the **VIEW/EDIT** DIP switch to the **EDIT** position. The bottom line of the LCD will change; 'New=XX' will appear where XX is the current value of the memory address.

Use the **UP** and **DN** push buttons to change the value. Use the **SHIFT** push button to switch to the next digit. When the value you want is displayed, press the **WR** (WRITE) push button to record the new value permanently.



CAUTION: Write down the value of the parameter before you begin changing it. If you make a mistake, you can always restore the old value.



WARNING: If you realize you made a mistake, **DO NOT** PRESS THE **WR** BUTTON. Instead, skip that step and move the **VIEW/EDIT** DIP switch to the **VIEW** position. The old value will automatically be restored.

ON A MENU VIEW



OFF B SUB EDIT

UP DN SHIFT

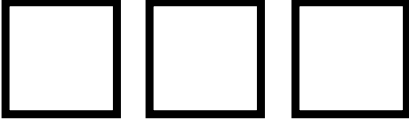

1. Set the DIP switches as shown to change a User Display parameter. Use the **UP**, **DN** and **SHIFT** push buttons to change the value of the parameter.

WR



2. Press the **WR** (WRITE) push button to record your changes permanently. Skip this step if you decide that you don't want to record your changes permanently.

ON A MENU VIEW



OFF B SUB EDIT

3. Move the **VIEW/EDIT** DIP switch back to the position shown. To select another Parameter in the selected sub-menu, use the **UP** and **DN** push buttons. To select another User Display submenu, start over again as on the previous page.

1.6 Direct Access User Display

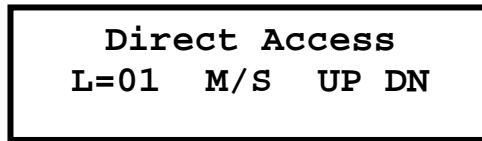

The Direct Access User Display menu bypasses many of the other menus. Use this menu when directed by Elevator Controls technical support. For those familiar with EC's MPC-P7 computer boards, you can reprogram the P8 or PIO9 in a similar "address/data" fashion as done with the P7 switchgear. The reprogramming address conversions are: (P7) E400's = FC00's (P8 or PIO9), and (P7) E700's = FF00's (P8 or PIO9).



NOTE: The entire parameter reprogramming area for software version 5.x covers from FB00 to FFFF, and for software versions 1.xx.xx and 3.xx.xx from FA00 to FFFF.

To view "Memory Flags, inputs and outputs," use direct access and refer to the "Memory Flag Listing" tables section 1.17 pages 30 for version 5.x, page 31 for version 1.xx.xx and page 32 for version 3.xx.xx of this manual.

Normally, you will use one of the following User Display menus:

- To change system clock, use the **Set Clock** User Display menu.
- To change car timers, use the **Car Timers** User Display menu.
- To change car control variables, use the **Car Control** Display menu.
- To change system timers, use the **System Timers** User Display menu.
- To change system I/O programming, use the **System Control** User Display menu.
- To change floor stopping variables, use the **Stopping Table** User Display menu.
- To change door operation, use the **Door Options** User Display menu.
- To change fire service options, use the **Fire Options** User Display menu.

1.7 Set Time Clock Parameters

Set Clock Time L=07 M/S UP

Use the Set Clock Time User Display to change your date and time display. The table below lists all of the options available within the Set Clock Time menu. Use the **UP** and **DN** push buttons to select parameters to view.

Time Clock Parameters

Parameter	Function
Clk: Seconds 00-59	Sets the current second for the system clock.
Clk: Minutes 00-59	Sets the current minute for the system clock.
Clk: Hours 00-23	Sets the current hour for the system clock. The clock uses military time. Examples: 00 hour is midnight to 12:59AM. 13 hour is 1:00 PM to 1:59 PM.
Clk: Day SUN, MON, TUE,... SAT	Sets the current day of the week. SUN=Sunday, MON=Monday, TUE=Tuesday, WED=Wednesday, THU=Thursday, FRI=Friday and SAT=Saturday
Clk: Date 01-31	Sets the current day of the month.
Clk: Month JAN, FEB, MAR,, DEC	Sets the current month of the year. JAN=January, FEB=February, MAR=March, APR=April, MAY=May, JUN=June, JUL=July, AUG=August, SEP=September, OCT=October, NOV=November, DEC=December.
Clk: Year 00-99	Two digit year (e.g., enter 04 for 2004)

1.8 Fault Log List

```
Fault Log List
L=xx M/S UP
```

 **NOTE:** xx indicates the number of faults in the fault buffer from 0 to 25.

The Fault Log List User Display is used to view up to the last 25 faults logged. Upon entering this menu, move the Menu/ Sub switch to Sub position, to view the following display. **If the fault log needs to be cleared, press the WR button.** If you want to view and keep the existing fault log, simply scroll through the faults using the **UP** and **DN** buttons.

```
Fault Log
Write Clears All
```

Once the **UP** or **DN** button is pressed, fault entries will be displayed. The display has four quadrants: The fault entry number appears at the top left corner, the fault code at top right corner, date of fault occurrence at bottom left corner, and time, time is displayed in military format 24 hour clock, of occurrence at bottom right corner.

```
01 Fault=07
Jan 12 11:11:35
```

 **NOTE:** Pressing the **DN** button first positions the fault pointer at the most recent fault logged in the buffer, pressing the **UP** button first places fault pointer to oldest fault logged.

To display the car position and translate the fault code, simply place the View switch in the Edit position to show car position at time of fault, on the top line, and the fault code translation will scroll on the bottom line of LCD display.

```
PI=01
Safety String Open
```

To go back to fault scroll mode simply place the **EDIT** switch back to **VIEW** and repeat steps above to scroll through rest of fault history.

1.9 Car Timers

Car Timers
L=12 M/S UP

Use the Elevator Timers User Display to review and adjust the car function timers. The table below lists parameters available within the Elevator Timers sub-menu. Use the **UP** and **DN** push buttons to select one of the parameters below.

 **NOTE:** The **Car Timers** can only be used to change timer values from 0 to 99 seconds. The Direct Access menu is used to set timer values over 99 seconds. Contact Elevator Controls for assistance in resetting timer values over 99 seconds.

 **NOTE:** Timers can be disabled by setting both timer address parameters to 00, using Direct Access menu.

Car Timers

Timer Parameter (Direct Access Address)	Function
Close Prtn Timer (FFA0 - FFA1)	Sets the maximum time that power will be applied to the doors for closing before a reopen, if the doors fully closed position is not achieved. Default = 30 seconds.
Open Prtn Timer (FFAA – FFAB)	Sets the maximum time allowed for the doors to achieve full open position before closing, opening stops if DOL is broken regardless of timer status. Default = 30 seconds
Short Door Timer (FFA2 – FFA3)	Sets the time the doors will wait at the open limit after opening when a door reopening device is activated. Default = 2 seconds.
Car Door Timer (FFA4 – FFA5)	Sets the time the doors will wait at the open limit after opening for a car call. Default = 3 seconds.
Hall Door Time (FFA6 – FFA7)	Sets the time the doors will wait at the open limit after opening for a hall call. Default = 7 seconds.
Eq Normal Timer (FFA8 - FFA9)	Sets delay to wait after the seismic switch returns to normal before car is allowed to return to run on earthquake automatic operation mode. Default = 30 seconds.
∞ Eq Abnormal Timer » Eq Door Timer (FFAC - FFAD)	Sets delay to wait before opening the car doors once the car stops into door zone after an earthquake occurrence. Default = 05 seconds.
Eq Stop Timer (FFB2 - FFB3)	Recovery time to wait before moving car to door zone area after counterweight derailment. Default = 10 seconds.
Lobby Door Timer (FFB0 - FFB1)	Sets time to wait with doors open on a hall call at the lobby floor. Default = 10 seconds.
Gong Double Ding (FFB4 - FFB5)	Sets the time between pulses for a double ding on the Gongs. Default = 00.

Gong Hold Timer (FFB6 - FFB7)	Sets time to hold gong pulse active. Default = 3 seconds
Door Hold Timer (FFBC - FFBD)	Sets the time the doors will remain open after breaking the door open limit if the door hold input is activated. Default = 10 seconds.

1.10 Car Control

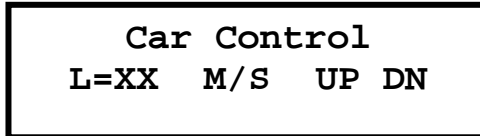

Software Version 5.x: L = 15 and Software Version 1.xx.xx: L = 16

Use the Car Control User Display to view or change system parameters for a simplex, duplex/groupless pair or group system. The table below lists parameters available in the Car Control submenu. Use the **UP** and **DN** push buttons to select one of the parameters below.

Many of these parameters will change the I/O configuration of the controller. These parameters are marked with a †. Do not change these parameters without contacting Elevator Controls technical support staff for assistance.



WARNING: Do not change † parameters (below) without first contacting Elevator Controls technical support staff for assistance.

Car Control

Bottom Floor No.	Normally 00. Determines the starting level which this car services. Example: A duplex system, if this car has no basement landing but the other car does this car will be 01 the other will be 00.
† Hall Call Rej Op	Enables HCRO output if set to 01; disables if set to 00.
Hi Speed Step Op	Normally set to 00. Set to 20 on jobs that require slowdown distances greater than the shortest floor height. Set to 20 for all PVF traction controllers (SDI board).
Hydro Option 00=N,01=Y	Traction controllers = 00 Hydraulic controllers = 01

Input Option 1	A hex number with seven options. See appendix A for complete information on hex numbers. The hex number is: M: X ATT UCR DCR; L: CCR UCF DCF CCF Descriptions: CCF- Set to 1 to enable Front Car Call input † DCF- Set to 1 to enable Front Down Call input † UCF- Set to 1 to enable Front Up Call input † CCR- Set to 1 to enable Rear Car Call input † DCR- Set to 1 to enable Rear Down Call input † UCR- Set to 1 to enable Rear Up Call input † ATT- Set to 1 to enable Attendant inputs & outputs † PitSw-Set to 1 to enable Pit Switch input option †
† Input Option 2	Factory set. Do not change. †
† Input Option 3	Factory set. Do not change. †
† Input Option 4	Factory set. Do not change. †
» † Input Option 5	Factory set. Do not change. †
LCD Display Rate	Controls the LCD scroll rate. Normally set to 05.
PC display Optn	Used to select type of monitoring system connected to the controller.
Lobby Floor No.	Set to lobby floor level minus 1. i.e.: bottom floor = 00.
Top Floor No.	Set to top level number minus 1. i.e. top floor level 5 = 04.
† Number of PI's	Set to the number of PI outputs on the system.
Alt Park Floor	Set to level value minus 1 for which the car is to park when the alternate parking floor input is active.
SDI Option (PVF)	Set to 01 for jobs with position velocity feedback (PVF). Otherwise set to 00.
† These options will cause wiring terminals to change function. Elevator Controls technical support staff will need to assist you in rewiring your system if you change one of these options. Record current values before changing.	

1.11 System Timers

System Timers
L=18 M/S UP DN

The table below lists parameters available in the System Timers submenu. Use the **UP** and **DN** push buttons to select one of the parameters below.

 **NOTE:** Timer values are in seconds.

 **NOTE:** Timers can be disabled by setting the Direct Access parameters to 00.

System Timers

Timer Name (Direct Access Parameters)	Description
Delta-Wye Timer (FF60 – FF61)	Sets the time to switch motor starter from Wye to Delta mode, or to go from brake pick to brake hold voltage on traction jobs. Default = 2 seconds.
Vic On Timer (FF62 – FF63)	Sets the time the pump motor will be turned on while on Viscosity control mode of operation. Default = 3 minutes (Display shows 19sec)
Vic Off Timer (FF64 – FF65)	Sets the time the pump motor will be turned OFF while on Viscosity control mode of operation. Default = 9 minutes (Display shows 69sec)
Piston Sync Tmr (FF76 – FF77)	Sets the time allowed to complete the dual piston synchronization before going back to normal operation.
MG Timer (FF68 – FF69)	Used for two purposes. Traction Controller = The time a generator is allowed to run before shutting down if there is no activity. Default = 90 seconds. Hydraulic Controller = The soft stop pump timer. Default = 1 second
MG Lockup Tmr (FF6A – FF6B)	Sets the maximum time allowed for the starter to switch the Delta feedback input before declaring a car starter stuck in Wye fault. Default = 15 seconds.
Trip-fail Timer or Motor Limit Timer (FF6C – FF6D)	Sets the maximum time the car is allowed to run in the hoist way for a single non-stop trip. Default = 180 seconds. (Display shows 20sec) Note: 900 controller manuals call timer Motor Limit Timer instead of Trip Failure Tmr as shown on LCD display

TOS Timer (FF6E – FF6F)	Sets the time the car can normally be held at a floor before the system attempts to use nudging to close the doors. Default = 45 seconds.
Sec Code Timer (FF70 – FF71)	Sets the time allowed between car call coded security button entries. Default = 05 seconds.
» Idle Timer (FF74 – FF75)	The Idle output (if provided) is activated after this timer elapses. The timer starts once doors are closed after the last request for demand. Default = 5 minutes. (Display shows 44sec)
α Park Release Tmr (FF80 – FF81)	Sets the time allowed upon demand before car is released from parking. Default = 30 seconds. Software version 5.x only.
Parking Timer (FF82 – FF83)	Sets the time the car remains idle (no demand) before the car is allowed to park. Default = 05 seconds
Hsp Trp-fail Tmr (FF84 – FF85)	Time allowed for the selected car to respond to Hospital Service Call. Default = 180 seconds (Display shows 20sec)
Hsp Door Timer (FF86 - FF87)	Sets the time allowed to take control of the car after car has responded to a hospital service hall call, before car returns to normal operation mode. Default = 30 seconds.
SU/SD Delay Tmr (FF88 – FF89)	Sets the time to hold SU or SD relay outputs after demand for direction has been lost. Default = 01 seconds
Brake Pick Timer (FF8A – FF8B)	Sets the time allowed for the brake contact to signal controller that the brake has picked. Default = 5 seconds
IND Hold Timer (FF8E / FF8F)	Sets the time to wait before taking car on fire service phase 1 return while car is on independent service. Default = 15 seconds.
Inspection Timer (FF90 / FF91)	For Ansi-2000, sets time to delays fault to allow exit from elevator. Default = 15 seconds.
EP Trip-fail Tmr (FF96 / FF97)	Sets the time allowed for the car to complete emergency power phase 1 recall. Default = 180 seconds. (Display shows 20sec)
» Drive Reset Tmr (FF98 / FF99)	Sets time the drive reset output is held active to reset a drive trip out mode. Default = 3 seconds.

1.12 System Control

System Control
L=XX M/S UP DN

Software Version 5.x: L = 10 and Software Version 1.xx.xx: L = 13



NOTE: System Control menu for software version 5.x contains 10 entries, and software version 1.xx.xx contains 13 entries. Refer to the applicable job System Control table below based on job software version and skip other System Control table. Software version and date can be found by viewing the User Menu - Software Version.

The System Control User Display presents options used for dispatching of two or more car control system behavior such as emergency power behaviors, parking, etc, but that will also apply to a one car system. The table below lists parameters available in the System Control submenu. Use the **UP** and **DN** push buttons to select one of the parameters below.

Some of the options should not be changed unless you are directed to do so by Elevator Controls technical support staff. These options will change the configuration of your I/O and will require rewiring. These options are marked with a †.



WARNING: Do not change † parameters (below) without first contacting Elevator Controls technical support staff for assistance.

System Control Software Version 5.x

Variable Option Name	Description
CCD on Reversal	Cancel car calls upon direction reversal. 00 = off; set to 80 for group systems.
CCD, Slwdn & Ind	Car will cancel car calls ahead while slowing down to the first car call target, while on Independent. 00= off, 80= on.
†Emergency Power Option	Normally 00. Set to 01 if the system has emergency power generators.
Excess Call Can.	Set to 82 to cancel car calls after 2 floors of no activity on the photo-eye. Set to 04 to cancel calls after 4 if the light load weight switch is active.
Nudging: on = 10	Door nudging output. Set to 00 to turn off
Lower Parking Fl	Set to floor number, minus one, of the main parking floor. Set to FF to turn off
Upper Parking Fl	Set to the floor number, minus one, of a 2nd parking floor. Set to FF to turn off
Sec Code Length	Number of digits making up the security sequences.
†Duplex Operation	00 = Simplex; 03 = Master car; 01 = Slave car.
Wild Option	Normally 00. Set to 10 to use Wild Operation.
EZ Link Advance	00 = EZ link off, 05= EZ Link to Top of Car on

System Control Software Versions 1.xx.xx and 3.xx.xx

Variable Option Name	Description
Car Priority	Set 01 for master car, 02 for Slave car, and 03 for a car working as part of a three or more cars group in conjunction with the G900 group dispatcher controller
Number of Cars	Set to 01 for Simplex operation, set to 02 for duplex/groupless pair operation, set to 00 a car working as part of a three or more cars group in conjunction with the G900 group dispatcher controller
Dispatch Help	Number of assigned calls a car has before it asks for help from the other car (duplex/groupless pair operation).
† Emergency Power Option	Set to 80 to enable emergency power return and to 81 to allow 1 car to run under emergency power generator power, or 83 to allow both cars to run under emergency power generator power.
† Hospital Service	Set to 80 to enable hospital service operation and to C0 to enable hospital service & hall call acknowledge indicator driver outputs
Zone 1 Park Floor	Main parking floor, set to floor level, minus one.
Zone 2 Park Floor	2 nd parking floor, set to the floor level, minus one.
CCD on Reversal	Cancel car calls upon direction reversal. 00 = off; set to 80 for group systems
CCD, Slwdn & Ind	Car will cancel car calls ahead while slowing down to the first car call target, while on Independent. 00= off, 80= on.
Excess Call Can.	Set to 82 to cancel car calls after 2 floors of no activity on the photo-eye. Set to 04 to cancel calls after 4 if the light load weigher switch is active.
Nudging: on = 10	Door nudging output. Set to 00 to turn off
Sec Code Length	Number of digits making up the security sequences.
EZ Link Advance	00 = EZ link2 OFF, 0D = EZ link2 Top of Car ON, 03= EZ link2 to Hall ON, 0B= EZ Link2 to both Hall and Top of Car ON

1.13 Door Options

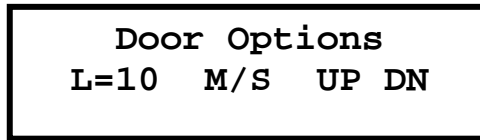

The Door Options User Display represents a variety of options that will affect elevator door operation. The table below lists parameters available in the Door Options submenu. Use the UP and DN push buttons to select one of the parameters below.

Some of the options should not be changed unless you are directed to do so by Elevator Controls technical support staff. These options will change the configuration of your I/O and will require rewiring. These options are marked with a †.



WARNING: Do not change † parameters (below) without first contacting Elevator Controls technical support staff for assistance.

Door Options

Variable Option Name	Description
Bth Door Lob Rtn	<p>0 0 F R F R F R</p> <p> + -- Rear door open on main fire return + + -- Front door open on main fire return + + + -- Rear door open on Alt. fire return + + + + -- Front door open on Alt. fire return + + + + + -- Rear door open Lobby up Peak + + + + + + -- Front door open Lobby up Peak</p> <p>Note: If set to 00 both doors will open on both fire return floors, and doors will stay closed on Lobby up peak return. Else set proper bit per above to selectively open doors in Fire Return Normal and Alternate services.</p>
Dbl Ding: DN =10	Normally set to 10, which generates two gong pulses for down travel. Set to 00 to generated one pulse for gongs which generate two pulses on their own.
DOB Enab: Nudging	Normally set to 20, which allows the door open button to reopen doors in nudging mode. Set to 00 to disable DOB in nudging mode.
Door Lk Dir Pref	Normally 00. Set to 80 to cancel direction preference (UPD and DPD) with DLK instead of DCF (do this only if directed by Elevator Controls support staff).

Door Lock Gong	Normally 80. Delay gongs until the door lock breaks (for jobs w/o hall gongs). Set to 00 to disable.
Door Time Short.	Normally 00. Set to 01 to prevent car call buttons from shortening door time. Set to 02 to shorten door time when a hall call, SE or PHE are activated. Set to 80 to close doors on lobby park and DBC or car call input.
† Miscel Option 1	Factory set. Do not change.
† Miscel Option 2	Factory set. Do not change.
† Rear Door Option	Set to 00 for front only or staggered rear doors. Set to 01 for selective rear doors. †
SE No Stop: Nudg	Normally 00. Set to 01 to ignore safety edge during nudging.

1.14 Fire Options

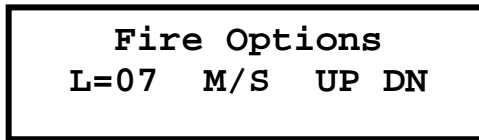

The Fire Options User Display represents a variety of options that will affect elevator operation during fire service phase 1 and phase 2. The table below lists parameters available in the Fire Options submenu. Use the **UP** and **DN** push buttons to select one of the parameters below.

Fire Options

Variable Name	Option	Description
Fire Code Option	7 6 5 4 3 2 1 0	Set bit to 1 for required fire code + -- ASME Fire service + + -- Not Used + + + -- Not used Bit always zero + + + + -- Not used Bit always zero. + + + + + -- New York City = 10h. + + + + + + -- Chicago = 20h. + + + + + + + -- ASME 1996 Fire Code + + + + + + + + -- Not used Bit always zero Note: For old California Fire option set bit 6, and option FF16 is set to 00, see Section 1.19 of this manual.
Mn. Fire Rtn:Cxh		Main Fire Recall Floor: Set to Cx, where x is the floor level, minus one.
Alt Fire Rtn: Cxh		Alternate Fire Recall Floor: Set to Cx, where x is the floor level, minus one.
SE qual: Phase 1		Normally 00. Set to 01 to prevent the Safety Edge from working on fire return operation.
SE qual: Phase 2		Normally 00. Set to 01 to prevent the Safety Edge from working on Phase 2 Fire Service.
Fire Hold: on=20		Normally 00. Set to FF to enable door hold button to work on Fire Phase 2 Fire Service.
Car Stop Bypass		Normally 00. Set to FF to bypass the car stop switch on Fire Phase 2 Fire Service. Set to 40 to bypass on fire service phase whether moving or not.

1.15 Stopping Table

Stopping Table
L=64 M/S UP DN

The Stopping Table User Display is used to program which and how many floors the elevator car will stop at. This is where changes are made if you need to increase or decrease the number of floors served by the system. This User Display also programs which calls (up, down and car calls) are accepted at each floor, so these submenus are used to set up functions such as down collective operation.

You can increase or decrease the number of stops in the system by adding or removing entire floors from the top of the stopping table. When you do this, you will need to change No. Floors-1 and Number of PI's parameters in the Car Control User Display submenu.



NOTE: Changing parameters in this User Display will cause the wiring to I/O to change. You should contact Elevator Controls Corporation technical support staff for help if you need to change any of these parameters.



WARNING: Do not change † parameters (below) without first contacting Elevator Controls technical support staff for assistance.

Stopping Table

Parameter	Function
† Car A Floor 1	Each parameter contains the hex coding for one floor of the elevator system. M: X X CCR CCF; L: UPR DNR UPF DNF † Description: DNF - Set to 0 to enable a down call at this floor. † UPF - Set to 0 to enable an up call at this floor. † DNR - Set to 0 to enable a rear down call at this floor. † UPR - Set to 0 to enable a rear up calls at this floor. † CCF - Set to 0 to enable a car call at this floor. † CCR- Set to 0 enable a car call rear X - Unused. Set to 1. X - Unused. Set to 1.
† Car A Floor 2	same as above †
† Car A Floor 3	same as above †
Etc.	etc.

Common Codes for Stopping Table

	Function
† FF	Car doesn't stop here. All your floors above the top one must have this code. †
† EE	One car call and one down call. This is the normal code for the top floor. †
† EC	One car call, up call and down call. This is the normal code for an intermediate floor. †
† ED	One car call and one up call. This is the normal code for the bottom floor, F11. †
† C0	All calls-front and rear car calls, up calls and down calls. This is the code for intermediate floors with front and rear openings. †
† DB	One rear car call and rear down call. A top floor with a rear opening only. †
† D3	One rear car call & rear up call and down call. An intermediate floor with a rear opening only. †
† D7	One rear car call and rear up call. A bottom floor with rear opening only. †
† Changing these parameters will change your terminal I/O configuration. Contact Elevator Controls support staff for assistance.	



NOTE: Software version 5.x has this car stopping table only, software version 1.xx.xx has a copy of the other car stopping table used for duplex/groupless pair hall call assignments when in a two car group mode of operation, each table is addressed by the A/B switch while on A position it points to **this** car's stopping table and while on B to the **other** car's stopping table, therefore for proper dispatching operation make sure to modify the four stopping tables, two in each car if job is configured for two car group operation.

To modify both stopping tables locate the floor you need to change with the A/B switch on the A position, **this** car's stopping table, modify contents as required following common stopping tables contents stop codes as needed, then flip the A/B switch on the B position, to address the **other** car's stopping table, modify contents as required following common stopping tables contents stop codes as needed, repeat the same procedure on the other car as required.



NOTE: Controllers using software version 1.xx.xx and arranged as duplex/groupless pair system, both cars will have the same hall call input output I/O so that either of the cars will be able to perform the group hall call assignments and dispatching.

1.16 Password Access

A password is a way to protect your controller from unauthorized users. A password will prevent unauthorized changes to field reprogrammable controller data and personality parameters. Unless the correct password is entered, the P8 or PIO9 microprocessor will ignore the **WR** (Write) push button when a personality address is displayed, thereby preventing data from being changed. A new password must be entered before changing or deactivating the current password.

The controller can be reprogrammed by first entering the four character password key. Entering the correct key will enable the **WR** write push button, allowing changes to be made to controller personality parameters. Cycling power or resetting the P8 or PIO9 microprocessor (pushing the “Reset” button) will remove the password entered.

Password Access
L=01 M/S UP DN

With the main menu displaying Password Access, lower the **MENU/SUB** switch to display:

Enter Password
Val= 0000

Press the **UP** or **DN** buttons to cycle through 1 – 9 and A – Z. Press the **SHIFT** button to cycle clockwise through the four characters. Finally press the **WR** button to compare the digits on the password entry display to the master password. If there is a match, **OK** will be display on the LCD screen. Raise the **MENU** and **VIEW** switch to exit to the main menu or lower the **ON / OFF** switch to exit the menu system.

The password remains active for approximately two hours and twenty minutes during which time the personality parameters may be changed. The controller LCD will display “Password Active”.

The password is disabled upon entry of the master password (0000) allowing access to all personality parameters. No message will be displayed on the controller LCD screen.

Starting with all switches in the up position, lower the **MENU/SUB** switch from the Password Access menu, to display the change password screen.

Change Password
UP / DN

Lower the **VIEW/EDIT** switch to edit the current password.

Change Password
Val= KORN

Press the **UP** or **DN** buttons to cycle through 1 – 9 and A – Z. Press the **SHIFT** button to cycle clockwise through the four characters. The LCD screen will display “Saved” upon pressing the **WR** button and saving the new password key.

Change Password
Val= KORN Saved

Raise the **MENU** and **VIEW** switch to exit to the main menu or lower the **ON/OFF** switch to exit the menu system.

Prevent changes to the personality parameters while away from the controller by disabling or removing the password key. Starting with all switches in the up position, lower the **MENU/SUB** switch from the Password Access menu to display the change password screen. Press the **UP** or **DN** buttons to display:

Deactivate PW?
UP DN

Lower the **VIEW/EDIT** switch to display:

Deactivate PW?
WR clears PW

Upon pressing the **WR** button the password key is removed deactivating the **WR** button, while the master password value remains unchanged.

1.17 Memory Flags List

Use the Direct Access User Display to view memory flags. This is an important debugging aid. If you suspect that the system is not responding to a signal, check the memory flags to determine whether the computer is actually receiving or trying to send an output signal.

Make sure the signal is present on the IO-7 or PIO9 board by verifying the LED indicator associated with the signal, or by verifying correct signal voltage at the signal terminal or test point (if available). If the signal is present there (but not visible in the memory flags), a defective board may be preventing the elevator computer from receiving the signal.

Using the Direct Access menu, dial up the address of the signal or signals to be observed (please note the addresses associated with each group of signals on table below).

Using table MPC P8 SOFTWARE VERSION 5.x for software version 5.x or Groupless P8 or PIO9 Software Version 1.xx.xx or 3.xx.xx identify the signal in question and refer to the associated LED from 1L to 8M. To properly observe the actual signal behavior, is recommended that the LEDs be used, since each LED is associated with a specific signal and the LCD display may not have a fast enough refresh rate to display all signal changes, potentially confusing rather than aiding diagnosis.

Refer to Appendix B for proper identification of the mnemonic used to identify each signal.

EXAMPLE: To view the status of DOB, door open button input.

1. Using the direct access menu select memory address F001.
2. Identify LED 4M as representing DOB button input.
3. Observe whether the LED on the computer follows the status of the door open button.



NOTE: Some of the mnemonic names have been underscored denoting an active low signal, where the LED is off when the signal is active (ie: DOL, door open limit switch, where LED will be off if switch is open).



NOTE: The following memory flag charts are copies of the memory flag table found applied to the inside of the controller door.

Bar over signal name indicates the signal is active when LED is off.

MEMORY FLAG LISTING

"DIRECT ACCESS" ADDRESS		Left/Right Most L.E.D.											
		⑧	④	②	①	①	⑧	④	②	①	②	④	①
F-0-0-0	DOLF		DBCf		LLI		FRA		STU		STD		IND
F-0-0-1	IN	DOBF	DLK	SAF	DEL	UPS	FRS	DNS	DNS	LVL	EPI		
F-0-0-2	SEF	PHBF	DZF	FRS	FRS	FCS	USD1	DSD1	DSD1	DHLDF			
F-0-0-3	USD2	USD2	ISTU	ISTU	ISTD	ATT	UP	DN	DN	HUI			
F-0-0-4	PTR	PTS	N5B	BPI	BPI	BSI	ACS	HSI	WILD				
F-0-0-5	DOLR	DBCR	DOBR	DHLDR	DHLDR	PITF	SER	PHER	DZR				
F-0-0-6	EQI	CWI	EDS	APF	APF	PGI	CSI	DCLR	DCLR				
F-0-0-7	MGR/AA	CSB	HR	HR	HR	DOFF	SU	SD	RL				
F-0-0-8	DCFF	DCPF	EQS	NUDG	NUDG	SPR	FGEU	FGED	MPR				
F-0-0-9	FWI	85X	SUA	SDA	SDA	P4	P3	P2	P1				
F-0-0-A	ATE	ATB	ATU	ATD	ATD	HEWI	HCRO	HLWO	SALRM				
F-0-0-B	DOFR	RGEU	RGED	EQAM	EQAM	DCFR	DCPR	EPIM	SAFM				
F-0-0-C	TFAR	CCR	UCR	DCR	DCR	NDSR	FDCR	DPD	UPD				
F-0-0-D	LTR	HCTR	CCTR	SDTR	SDTR	UFQ	FDCF	DHOR	XREL				
F-0-0-E	STRE	TFX	DSF	DOIR	DOIR	FRM	FRC	EQN	EOA				
F-0-0-F	HCR	INC	ISV	CCD	CCD	PK	TFD	BFD	STC				
F-0-1-0	DOPH2	CMC	CCA	CCB	CCB	MLT	DCA	DCB	MCSB				
F-0-1-1	UFP	LFP	DMU	DMD	DMD	TFAF	CCF	UCF	DCF				
F-0-1-2	DSM	mIS	DOMR	PGO	PGO	DOMF	UCA	UCB	fireCSB				
F-0-1-3	DDF	-	CCCI	HSR	HSR	YBP	RECOV	GTUE	GTDE				
F-0-1-4	PHTX	FCSWO	LCD	ISRT	ISRT	SHLD	ISC	SELDLY	HSEL				
F-0-1-5	DOLMF	EPS	FCSM	DHLDTF	DHLDTF	DOLMR	NDGBPS	DCC	DHLDTR				
F-0-1-6	CAC	CBC	UDP	DDP	DDP	LTF	HCTF	CCTF	SDTF				
F-0-1-7	DIN	CCHOLH	DHOF	DOIF	DOIF	RUN	HD	H	HI				
F-0-1-8	LRC	LRf	DPR	THO	THO	LBF	ISR	YRQ	TOS				
F-0-1-9	NDSF	STE	SOH	STCP	STCP	ECC	LWQ	HLW	LLW				
F-0-1-A	REV	GHTF	PSTX	GHTR	GHTR	DSR	fireMlt	OUTDZ	DZORDZ				
F-0-1-B	PRT	TPR	HCDX	FIREMEM	FIREMEM	aFire	mFire	HF2	HF1				
F-0-1-C	LU	LD	FON	insCT	insCT	insINC	insACC	insUP	IDLE				
F-0-1-D	OFF	CTL	EPPT	SHNT	SHNT	fireOut	PIT	PITI					
F-0-1-E	fp2	FBPM	FBP	-	-	-	DHPO	DHLO	LOIL				
F-0-1-F	DRSOK	DSOF	DISC	DISCF	DISCF	DLYO	SSM	SSAFM	LSSM				
F-1-C-0	teshp	FCS	FBPI	FONI	FONI	HF2i	HF1i	FRAI	FRSi				
F-1-C-1	SSM	SSAFM	LSSM	DCLF	DCLF	DOLF	DHLDF	IND	LLI				
F-1-C-2	CGF	HDCDM	STPM	CSBM	CSBM	stopM	DZM	GOV	GTSM				
F-1-C-3	DRST	GTSX	CGR	HDR	HDR	flRst	DSAF	THD	DLM				
F-1-C-D				bbOut	bbOut				LvOut				
F-1-C-E			inStop			pOut			gisOut				

Note: Hydraulic Elevators (only) High Speed on Inspection option, program Address FCBB to 02, verify local elevator code for compliance before changing. Controller shipped with option set to off

CONTROLS and INDICATORS

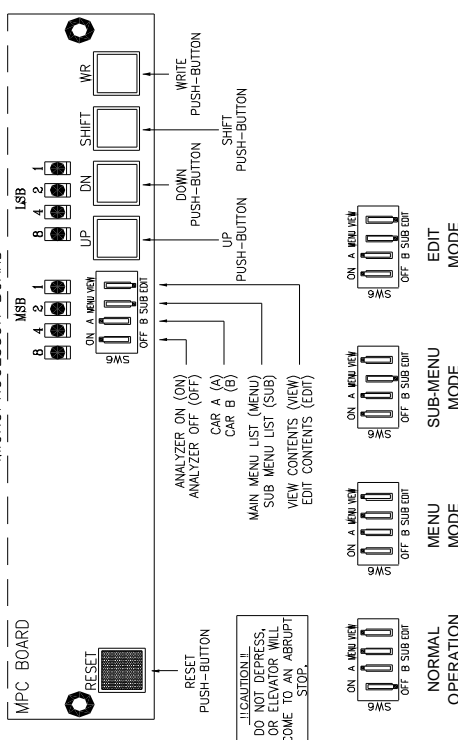

"WARNING"

For proper operation of Static Drive and Microprocessor Controller must ensure that:

- Incoming controller power and outgoing motor power wires are routed in separate grounded conduits, and routed away from printed circuit boards. **"DON'T ROUTE MOTOR AND POWER WIRES TOGETHER"**
Routing incoming power and outgoing motor power wires together may induce noise into power lines, and render "RFI" filters ineffective.
- Properly ground motor and controller with direct solid wire. Indirect grounds that rely on pipes or conduit instead of a properly sized solid ground are a poor practice and may result in "RFI" noise disturbances affecting electronic sensitive equipment.

"ENVIRONMENTAL LIMITS"

32 TO 104 DEGREES FAHRENHEIT OR 0 TO 40 DEGREES CELSIUS, 95 % RELATIVE HUMIDITY (NON-CONDENSING).

MEMORY FLAG LIST												
BAR OVER SIGNAL NAME INDICATES THE SIGNAL IS ACTIVE WHEN LED IS OFF.												
LEFT MOST RIGHT MOST												
L.E.D.												
DIRECT ACCESS ADDRESS	(8M)	(4M)	(2M)	(1M)	(8L)	(4L)	(2L)	(1L)				
F-0-0-0	DOLF	DBC	SAF	LLI	STU	IND	STD	IND				
F-0-0-1	IN	DOBF	DLK	DEL	DNS	EPI	LVL	EPI				
F-0-0-2	SEF	PHEF	DZF		USD1	DHLD	DSD1	DHLD				
F-0-0-3	USD2	DSD2	ISTU	TSTD	UP	HLI	DN	HLI				
F-0-0-4	TEST	DSD2	BPI	BSI	ACS	WILD	HSI	WILD				
F-0-0-5	DOLR	DBC	DOBR	DHLDR	SER	DZR	PHER	DZR				
F-0-0-6	EQI	CWI	EDS	APF	PGI	DCLF	DCLR	DCLF				
F-0-0-7	MGR/AA	CSB	HR	HIR	SU	RL	SD	RL				
F-0-0-8	DCFF	DCPF	EQS	NUDG	FGEU	MPR	FGEU	MPR				
F-0-0-9	IEQI	iCWI	SUA	SDA	P3	P1	P2	P1				
F-0-0-A	ATE	ATB	ATU	ATD	HEWI	SALRM	HLWO	SALRM				
F-0-0-B	DOFR	RGEU	RGED	EQAM	DCFR	SAFM	DCPR	SAFM				
F-0-0-C	epDO	CCR	UCR	DCR	NDSR	UPD	FDCR	UPD				
F-0-0-D	LTR	HCTR	CCTR	SDTR	UFQ	indi	FDCF	DHOR				
F-0-0-E	STRE	TFX	DSF	DOIR	YRQ	EOA	TOS	EQN				
F-0-0-F	HCR	INC	ISV	CCD	PK	STC	TFD	BFD				
F-0-1-0	NDSF	CMC	CCA	CCB	MLT	MCSB	DCA	DCB				
F-0-1-1	CSI		DMU	DMD	CCF	DCF	UCF	UCF				
F-0-1-2	DSM		DOMR	PGO	UCA	DCCR	UCA	DCCR				
F-0-1-3	DDF	eqReset	CCCI	HSR	YBP	GTDE	GTUE	GTDE				
F-0-1-4	DPR		doTop	startW	SHLD	SEL	ISC	SELDLY				
F-0-1-5	DOLMF	EPS	HLT	DHLDTF	DOLMR	DHLDTR	NDGBPS	DCCF				
F-0-1-6	CAC	CBC	UDP	DDP	LTF	SDTF	HCTF	CCTF				
F-0-1-7	DIIN	CCHOLH	DHOF	DOIF	RUN	SDF	HD	Hspeed				
F-0-1-8	mstrFire	FRC	FRM	FCC	FBPM	HI	FCSM	fireCSB				
F-0-1-9	FWI	X85	FCS	FDH	FCSWO	fireMIt	pHtX	DOPH2				
F-0-1-A	REV	GHTF	PSTX	GHTR	DSR	fireCSB	OUTDZ	DZORDZ				
F-0-1-B	RTN	TPR	HCDX	STCP		fireCSB	LWQ	HLW				
F-0-1-C	LU	LD		insCT	insINC	LLW	insACC	insUP				
F-0-1-D				SHNT	BLO	LLW	PIT	PITI				
F-0-1-E		forceDoors		STX	PIL	LLW	DHPO	DHLO				
F-0-1-F	drsOR	drsOF	drsCR	drsCF	DLYO	LOIL	SSAFM	LSSM				
F-1-C-2	CGF	HDBM	STPM	CSBM	stopM	LSSM	GOV	GSTM				
F-1-C-3	DRST	GTSX	CGR	HDR	fltrSt	LSSM	THD	DLM				
F-2-1-9				bbOut		LSSM		IMOut				
F-2-1-A				inStop		LSSM		gtsOut				
E-8-5-E	gFON2	gFBP		gFON1	gHF2	FRS	FRA	FRS				
E-8-5-F				gFRO		gEPI	gaFire	gmFire				
E-8-7-9	gEPO	gEPP	gHCDX		atLobby	gEPI	EPHSI	gEPI				
E-8-6-D												

NOTE: HYDRAULIC ELEVATORS ONLY
TO ENABLE HIGH SPEED ON INSPECTION OPTION, SET ADDRESS FCBB TO 02.
VERIFY LOCAL ELEVATOR CODE FOR COMPLIANCE BEFORE CHANGING.
CONTROLLER SHIPPED WITH THIS OPTION SET TO OFF.

ELEVATOR CONTROLS

SIMPLE SOLID SUPPORTABLE

GROUPLESS P8 or PIO9 SOFTWARE VERSION 1.XX.XX

DIAGNOSTIC CONTROLS & INDICATORS

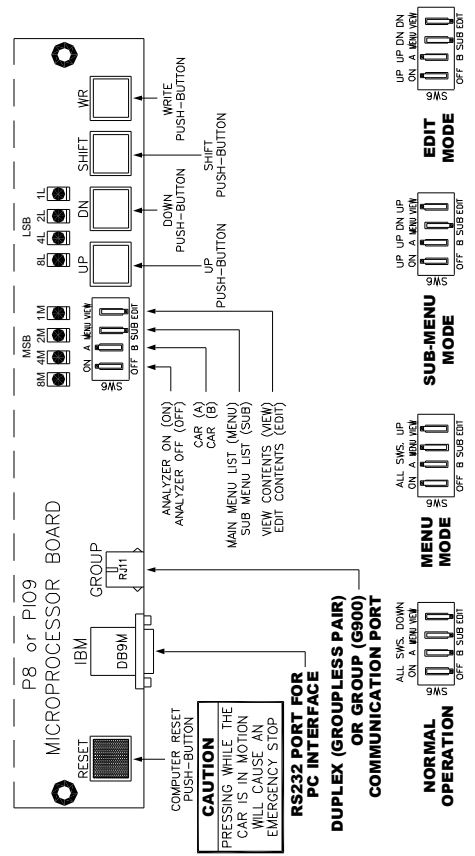

WARNING

For proper operation of the static drive and/or microprocessor controller ensure the following:

1. The incoming main line controller power and outgoing motor power wires are to be routed in separate grounded conduit. All power wires are to be routed away from printed circuit boards.
2. **"DO NOT ROUTE MOTOR AND MAIN LINE WIRES TOGETHER"** Routing these power wires together may induce noise into the power lines, and render "RFI" filters ineffective.
3. Proper grounding of the motor and controller is defined as a direct connection to EARTH GROUND. Indirect grounds that rely on pipes or conduit are not a sufficient ground and are considered a poor practice. Using pipes or conduit for ground may result in "RFI" noise disturbances affecting electronic sensitive equipment. Electrical ground (EARTH GROUND) should be obtained through a certified electrical contractor.

ENVIRONMENTAL LIMITS

32 TO 104 DEGREES FAHRENHEIT OR 0 TO 40 DEGREES CELSIUS
95% RELATIVE HUMIDITY (NON-CONDENSING)

File Group User Memory Flag Map Rev. 12-18-98

MEMORY FLAG LIST

BAR OVER SIGNAL NAME INDICATES THE SIGNAL IS ACTIVE WHEN LED IS OFF.

LEFT MOST L.E.D. RIGHT MOST L.E.D.

(8M) (4M) (2M) (1M) (8L) (4L) (2L) (1L)

DIRECT ACCESS ADDRESS	8M	4M	2M	1M	8L	4L	2L	1L
F-0-0-0	DOLF	DBCF	SAF	LLI	STU	IND		
F-0-0-1	IN	DOBF	DLK	DEL	DNS	STD		
F-0-0-2	SEF	PHEF	DZF		USD1	LVL		
F-0-0-3	USD2	DSD2	ISTU	ATT	UP	DHLD		
F-0-0-4	TEST	ANS	OLI	BPI	ACS	DN		
F-0-0-5	DOLR	DBCR	DOBR	DHLDR	SER	HLI		
F-0-0-6	EQI	CWI	DPI	APF	BLI	WILD		
F-0-0-7	MGR	CBSB	HR	HIR	DOFF	DCLR		
F-0-0-8	DCFF	DCPF	EQS	NUDG	SPR	SD		
F-0-0-9	ATE	ATB	SUA	SDA	P4	FGED		
F-0-0-A	DOFR	RGEU	ATU	ATD	HEWI	P2		
F-0-0-B	LTR	HCR	UCR	DCR	DCFR	P1		
F-0-0-C	STRE	TFX	DSF	DOIR	YRQ	SALRM		
F-0-0-D	HCR	INC	ISV	CCD	PK			
F-0-0-E	CSI	ISRT	DMU	DMD	MLT			
F-0-0-F	DDF	DDF	DOMR	PGO	DOMF			
F-0-0-G	DDR	DDR	CCC	HSR	YBP			
F-0-0-H	DOLMF	EPS	HLT	DHLDTF	SHLD			
F-0-0-I	CAC	CBC	UDP	DDP	DOLMR			
F-0-0-J	DIN	CCHOLH	DHOF	DOIF	LTF			
F-0-0-K	mstrFire	FRC	FRM	FCC	RUN			
F-0-0-L	FWI	X85	FCS	FDH	FCSWO			
F-0-0-M	REV	GHTF	PSTX	GHTR	DSR			
F-0-0-N	LU	LD	HCDX	STCP	OLW			
F-0-0-O	forceDoors	disOR	disOF	disCR	insINC			
F-0-0-P	CGF	HDBM	STPM	CSBM	BLO			
F-0-0-Q	DRST	GTSX	CGR	HDR	PIT			
F-0-0-R	switchChng	FBPI	inStop	bbOut	DHPO			
F-0-0-S	gFON2	gFON1	epTrans	gEP2	PIL			
F-0-0-T	gFON2	gFON1	gFON2	gFON1	DLYO			
F-0-0-U	gFON2	gFON1	gFON2	gFON1	SSAFM			
F-0-0-V	gFON2	gFON1	gFON2	gFON1	GOV			
F-0-0-W	gFON2	gFON1	gFON2	gFON1	THD			
F-0-0-X	gFON2	gFON1	gFON2	gFON1	DSAF			
F-0-0-Y	gFON2	gFON1	gFON2	gFON1	gEPO			
F-0-0-Z	gFON2	gFON1	gFON2	gFON1	gEP1			
F-0-1-A	gFON2	gFON1	gFON2	gFON1	gEP1			
F-0-1-B	gFON2	gFON1	gFON2	gFON1	gEP1			
F-0-1-C	gFON2	gFON1	gFON2	gFON1	gEP1			
F-0-1-D	gFON2	gFON1	gFON2	gFON1	gEP1			
F-0-1-E	gFON2	gFON1	gFON2	gFON1	gEP1			
F-0-1-F	gFON2	gFON1	gFON2	gFON1	gEP1			
F-0-1-G	gFON2	gFON1	gFON2	gFON1	gEP1			
F-0-1-H	gFON2	gFON1	gFON2	gFON1	gEP1			
F-0-1-I	gFON2	gFON1	gFON2	gFON1	gEP1			
F-0-1-J	gFON2	gFON1	gFON2	gFON1	gEP1			
F-0-1-K	gFON2	gFON1	gFON2	gFON1	gEP1			
F-0-1-L	gFON2	gFON1	gFON2	gFON1	gEP1			
F-0-1-M	gFON2	gFON1	gFON2	gFON1	gEP1			
F-0-1-N	gFON2	gFON1	gFON2	gFON1	gEP1			
F-0-1-O	gFON2	gFON1	gFON2	gFON1	gEP1			
F-0-1-P	gFON2	gFON1	gFON2	gFON1	gEP1			
F-0-1-Q	gFON2	gFON1	gFON2	gFON1	gEP1			
F-0-1-R	gFON2	gFON1	gFON2	gFON1	gEP1			
F-0-1-S	gFON2	gFON1	gFON2	gFON1	gEP1			
F-0-1-T	gFON2	gFON1	gFON2	gFON1	gEP1			
F-0-1-U	gFON2	gFON1	gFON2	gFON1	gEP1			
F-0-1-V	gFON2	gFON1	gFON2	gFON1	gEP1			
F-0-1-W	gFON2	gFON1	gFON2	gFON1	gEP1			
F-0-1-X	gFON2	gFON1	gFON2	gFON1	gEP1			
F-0-1-Y	gFON2	gFON1	gFON2	gFON1	gEP1			
F-0-1-Z	gFON2	gFON1	gFON2	gFON1	gEP1			
F-0-2-A	gFON2	gFON1	gFON2	gFON1	gEP1			
F-0-2-B	gFON2	gFON1	gFON2	gFON1	gEP1			
F-0-2-C	gFON2	gFON1	gFON2	gFON1	gEP1			
F-0-2-D	gFON2	gFON1	gFON2	gFON1	gEP1			
F-0-2-E	gFON2	gFON1	gFON2	gFON1	gEP1			
F-0-2-F	gFON2	gFON1	gFON2	gFON1	gEP1			
F-0-2-G	gFON2	gFON1	gFON2	gFON1	gEP1			
F-0-2-H	gFON2	gFON1	gFON2	gFON1	gEP1			
F-0-2-I	gFON2	gFON1	gFON2	gFON1	gEP1			
F-0-2-J	gFON2	gFON1	gFON2	gFON1	gEP1			
F-0-2-K	gFON2	gFON1	gFON2	gFON1	gEP1			
F-0-2-L	gFON2	gFON1	gFON2	gFON1	gEP1			
F-0-2-M	gFON2	gFON1	gFON2	gFON1	gEP1			
F-0-2-N	gFON2	gFON1	gFON2	gFON1	gEP1			
F-0-2-O	gFON2	gFON1	gFON2	gFON1	gEP1			
F-0-2-P	gFON2	gFON1	gFON2	gFON1	gEP1			
F-0-2-Q	gFON2	gFON1	gFON2	gFON1	gEP1			
F-0-2-R	gFON2	gFON1	gFON2	gFON1	gEP1			
F-0-2-S	gFON2	gFON1	gFON2	gFON1	gEP1			
F-0-2-T	gFON2	gFON1	gFON2	gFON1	gEP1			
F-0-2-U	gFON2	gFON1	gFON2	gFON1	gEP1			
F-0-2-V	gFON2	gFON1	gFON2	gFON1	gEP1			
F-0-2-W	gFON2	gFON1	gFON2	gFON1	gEP1			
F-0-2-X	gFON2	gFON1	gFON2	gFON1	gEP1			
F-0-2-Y	gFON2	gFON1	gFON2	gFON1	gEP1			
F-0-2-Z	gFON2	gFON1	gFON2	gFON1	gEP1			
F-0-3-A	gFON2	gFON1	gFON2	gFON1	gEP1			
F-0-3-B	gFON2	gFON1	gFON2	gFON1	gEP1			
F-0-3-C	gFON2	gFON1	gFON2	gFON1	gEP1			
F-0-3-D	gFON2	gFON1	gFON2	gFON1	gEP1			
F-0-3-E	gFON2	gFON1	gFON2	gFON1	gEP1			
F-0-3-F	gFON2	gFON1	gFON2	gFON1	gEP1			
F-0-3-G	gFON2	gFON1	gFON2	gFON1	gEP1			
F-0-3-H	gFON2	gFON1	gFON2	gFON1	gEP1			
F-0-3-I	gFON2	gFON1	gFON2	gFON1	gEP1			
F-0-3-J	gFON2	gFON1	gFON2	gFON1	gEP1			
F-0-3-K	gFON2	gFON1	gFON2	gFON1	gEP1			
F-0-3-L	gFON2	gFON1	gFON2	gFON1	gEP1			
F-0-3-M	gFON2	gFON1	gFON2	gFON1	gEP1			
F-0-3-N	gFON2	gFON1	gFON2	gFON1	gEP1			
F-0-3-O	gFON2	gFON1	gFON2	gFON1	gEP1			
F-0-3-P	gFON2	gFON1	gFON2	gFON1	gEP1			
F-0-3-Q	gFON2	gFON1	gFON2	gFON1	gEP1			
F-0-3-R	gFON2	gFON1	gFON2	gFON1	gEP1			
F-0-3-S	gFON2	gFON1	gFON2	gFON1	gEP1			
F-0-3-T	gFON2	gFON1	gFON2	gFON1	gEP1			
F-0-3-U	gFON2	gFON1	gFON2	gFON1	gEP1			
F-0-3-V	gFON2	gFON1	gFON2	gFON1	gEP1			
F-0-3-W	gFON2	gFON1	gFON2	gFON1	gEP1			
F-0-3-X	gFON2	gFON1	gFON2	gFON1	gEP1			
F-0-3-Y	gFON2	gFON1	gFON2	gFON1	gEP1			
F-0-3-Z	gFON2	gFON1	gFON2	gFON1	gEP1			
F-0-4-A	gFON2	gFON1	gFON2	gFON1	gEP1			
F-0-4-B	gFON2	gFON1	gFON2	gFON1	gEP1			
F-0-4-C	gFON2	gFON1	gFON2	gFON1	gEP1			
F-0-4-D	gFON2	gFON1	gFON2	gFON1	gEP1			
F-0-4-E	gFON2	gFON1	gFON2	gFON1	gEP1			
F-0-4-F	gFON2	gFON1	gFON2	gFON1	gEP1			
F-0-4-G	gFON2	gFON1	gFON2	gFON1	gEP1			
F-0-4-H	gFON2	gFON1	gFON2	gFON1	gEP1			
F-0-4-I	gFON2	gFON1	gFON2	gFON1	gEP1			
F-0-4-J	gFON2	gFON1	gFON2	gFON1	gEP1			
F-0-4-K	gFON2	gFON1	gFON2	gFON1	gEP1			
F-0-4-L	gFON2	gFON1	gFON2	gFON1	gEP1			
F-0-4-M	gFON2	gFON1	gFON2	gFON1	gEP1			
F-0-4-N	gFON2	gFON1	gFON2	gFON1	gEP1			
F-0-4-O	gFON2	gFON1	gFON2	gFON1	gEP1			
F-0-4-P	gFON2	gFON1	gFON2	gFON1	gEP1			
F-0-4-Q	gFON2	gFON1	gFON2	gFON1	gEP1			
F-0-4-R	gFON2	gFON1	gFON2	gFON1	gEP1			
F-0-4-S	gFON2	gFON1	gFON2	gFON1	gEP1			
F-0-4-T	gFON2	gFON1	gFON2	gFON1	gEP1			
F-0-4-U	gFON2	gFON1	gFON2	gFON1	gEP1			
F-0-4-V	gFON2	gFON1	gFON2	gFON1	gEP1			
F-0-4-W	gFON2	gFON1	gFON2	gFON1	gEP1			
F-0-4-X	gFON2	gFON1	gFON2	gFON1	gEP1			
F-0-4-Y	gFON2	gFON1	gFON2	gFON1	gEP1			
F-0-4-Z	gFON2	gFON1	gFON2	gFON1	gEP1			
F-0-5-A	gFON2	gFON1	gFON2	gFON1	gEP1			
F-0-5-B	gFON2	gFON1	gFON2	gFON1	gEP1			
F-0-5-C	gFON2	gFON1	gFON2	gFON1	gEP1			
F-0-5-D	gFON2	gFON1	gFON2	gFON1	gEP1			
F-0-5-E	gFON2	gFON1	gFON2	gFON1	gEP1			
F-0-5-F	gFON2	gFON1	gFON2	gFON1	gEP1			
F-0-5-G	gFON2	gFON1	gFON2	gFON1	gEP1			
F-0-5-H	gFON2	gFON1	gFON2	gFON1	gEP1			
F-0-5-I	gFON2	gFON1	gFON2	gFON1	gEP1			
F-0-5-J	gFON2	gFON1	gFON2	gFON1	gEP1			
F-0-5-K	gFON2	gFON1	gFON2	gFON1	gEP1			
F-0-5-L	gFON2	gFON1	gFON2	gFON1	gEP1			
F-0-5-M	gFON2	gFON1	gFON2	gFON1	gEP1			
F-0-5-N	gFON2	gFON1	gFON2	gFON1	gEP1			
F-0-5-O	gFON2	gFON1	gFON2	gFON1	gEP1			
F-0-5-P	gFON2	gFON1	gFON2	gFON1	gEP1			
F-0-5-Q	gFON2	gFON1	gFON2	gFON1	gEP1			
F-0-5-R	gFON2	gFON1	gFON2	gFON1	gEP1			
F-0-5-S	gFON2	gFON1	gFON2	gFON1	gEP1			
F-0-5-T	gFON2	gFON1	gFON2	gFON1	gEP1			
F-0-5-U	gFON2	gFON1	gFON2	gFON1	gEP1			
F-0-5-V	gFON2	gFON1	gFON2	gFON1	gEP1			
F-0-5-W	gFON2	gFON1	gFON2	gFON1	gEP1			
F-0-5-X	gFON2	gFON1	gFON2	gFON1	gEP1			
F-0-5-Y	gFON2	gFON1	gFON2	gFON1	gEP1			
F-0-5-Z	gFON2	gFON1	gFON2	gFON1	gEP1			

NOTE FOR HYDRAULIC ELEVATORS ONLY:
 TO ENABLE HIGH SPEED ON INSPECTION OPTION, SET ADDRESS FCBB TO 02.
 VERIFY LOCAL ELEVATOR CODE FOR COMPLIANCE BEFORE CHANGING.
 CONTROLLER SHIPPED WITH THIS OPTION SET TO OFF.

ELEVATOR EC CONTROLS

SIMPLE SOLID SUPPORTABLE

GROUPLESS P8 or PIO9 SOFTWARE VERSION 3.XX.XX

DIAGNOSTIC CONTROLS & INDICATORS

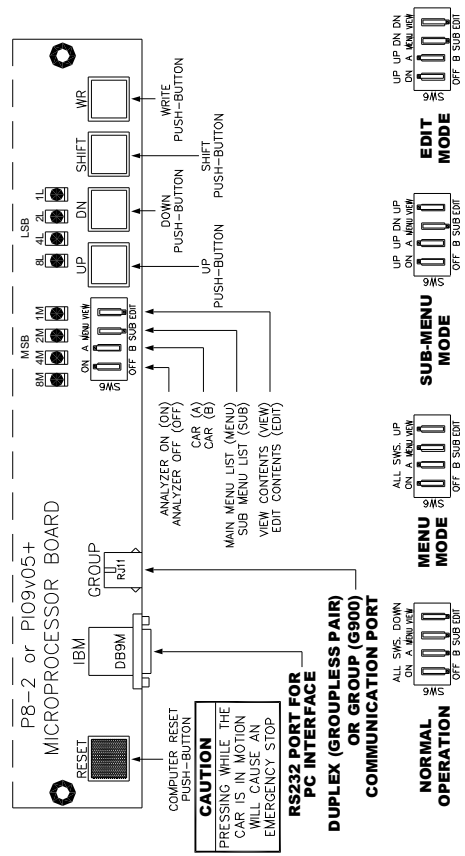

1.18 Software Version

<p style="text-align: center;">Version/ Job # L=01 M/S UP</p>

Submenu Switch down:

Submenu and Edit switches down:

<p style="text-align: center;">SW Version: X DD MMM YYYY</p>
--

<p style="text-align: center;">Job Number: 08-123456</p>
--

To verify the software version, use the User Display to access the Software Version submenu.

1.19 ASME A17.1-200x Settings

If the controller is to comply with the requirements of ASME Code A17.1-200x (where x is the release year of the applicable safety code section), the controller will be provided with an A17.1-2000 Monitor Board (P8 and P8-2 controllers only; A17.1-2000 circuitry is built into the PIO9 board) and the following Direct Access parameters will have been set. The table below lists parameters required for ANSI-200x operation.



WARNING: Do not change † parameters (below) without first contacting Elevator Controls support staff for assistance.

ANSI-2000 Settings

Direct Access	Function
† FF16 = 09	Bit 0- 2000 code option bit † Bit 1- Car has PI's at lobby † Bit 2- Car has PI's at alternate fire floor † Bit 3- ∞ 2000 code, Monitor safeties through car B port † Bit 4- Rear Car Gate Monitoring input † Bit 5- Freight Doors ANSI-2000 monitoring Bit 6- Ignore Unintended Movement on Inspection Mode Bit 7- Daily GTS, GTSX monitoring cycle at 2:00 AM
FF18 = 05	Noise Filter; Number of computer loops before fault is latched
Inspection Timer (FF90 / FF91)	For Ansi-2000, sets time to delays fault to allow exit from elevator. Default = 15 seconds. Note: Timer can be set through System Timers menu.
† Changing this parameter will change your terminal I/O configuration. Contact Elevator Controls support staff for assistance.	

Appendix A – Working with Hexadecimal Numbers

Elevator Controls uses hexadecimal (hex) numbers in several of the User Displays. Hex numbers are a compact way of representing information.

A1 – Converting Hexadecimal Numbers

Hex numbers are always displayed as two digits. The first digit (left hand side) contains the M or most significant information; the second digit (right hand side) contains the L or least significant information. The digits themselves use the number 0 through 9 and letters A through F.

Hex Numbers

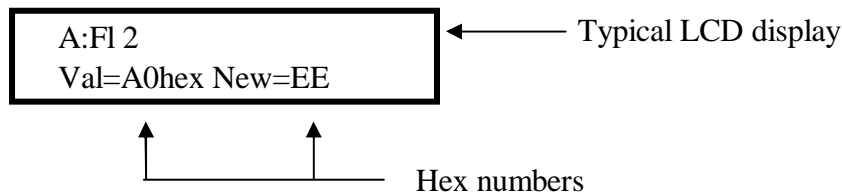

In the example above, A0 and EE are the hex numbers. A and E are the M digits and 0 and E are the L digits. The M and L digits are indicated in the description in the text by bold letters.

To use hex numbers, you must convert each digit separately into a series of four ones and zeros. Use the table on the next page to do the conversion. Then compare the ones and zeros with the description given in the User Display.

Converting Hex Numbers

Example Conversion A:F1 2 VAL=C0hex (see page 16 Input Option 1)

Hex Number		C				0				
		↓				↓				
Converted		1	1	0		0	0	0		
		↓	↓	↓		↓	↓	↓		
Description	M	X	X	CCR	;	L:	UPR	DNR	UPF	DNF

Result This shows that car will respond to front and rear car calls (CCR/CCF =0), and to all hall calls front and rear (UPR=DNR=UPF=UPR=0) since a 0 here means "eligible" (see text).

Hexadecimal Number Conversions			
Hex Number	Conversion	Hex Number	Conversion
0	0 0 0 0	8	1 0 0 0
1	0 0 0 1	9	1 0 0 1
2	0 0 1 0	A	1 0 1 0
3	0 0 1 1	B	1 0 1 1
4	0 1 0 0	C	1 1 0 0
5	0 1 0 1	D	1 1 0 1
6	0 1 1 0	E	1 1 1 0
7	0 1 1 1	F	1 1 1 1

A2 – Changing Hex Numbers

Changing a hex number is a four step process, whether it is an option, an internal flag or anything else. Follow the outline below:

1. Convert the hex number as described on the previous page. This will indicate which options are currently set.
2. Decide what options you want to set (or reset). If necessary, write the new series of ones and zeros down on paper. This will help verify that the new series is correct. Do not try to proceed until you've checked this new series at least once. It is very easy to make a conversion mistake.
3. Use the table above to look up the new hex number from the new series of ones and zeros. The ones and zeros are in no particular order so you'll have to search the table carefully. Double check that you have the correct new hex number (it is a good idea to convert the new number as described in the previous section).
4. Now change the hex number via the User Display as described on page 9 of this manual.

Changing a Hexadecimal Number

1. First convert the existing number to see which options are currently set. See instructions on the previous page.

A
1 1 0 0 0 0 0

X=1, X=1, CCR=0, CCF=0; UPR=0 DNR=0, UPF=0,
2. Then decide which options need to be changed. For example, assume that we only want the car to respond to car calls and hall up and down.

X=1, X=1, CCR=1, CCF=0; UPR=1 DNR=1, UPF=0,
1 1 0 0 1 1 0
3. Look up the new series of ones zeros in the table above.

C

4. Finally, follow the instructions on page 10 of this manual to change the number.

Appendix B –

B1 – Mnemonic description translation table and flag-LED memory locations

Name	Address	LED Bank										Description
		8	4	2	1	8	4	2	1			
ACS	F004						X					Alternate Call Scheme
aFire	F01B						X					Master Alternate Fire
APF	F006					X						Alternate Parking Floor Input
ATB	F00A		X									Attendant Buzzer
ATE	F00A	X										Attendant Enable
ATD	F00A				X							Attendant Down Direction Input
ATT	F003				X							Attendant Indicator
ATU	F00A			X								Attendant Up Direction Input
BFD	F00F								X			Bottom Floor Demand
BPI	F004				X							Brake auxiliary contact input
BSI	F004					X						Building Security Input
CAC	F016	X										Car Above Counterweight
CBC	F016		X									Car Below Counterweight
CCA	F010			X								Car Call Above Car
CCB	F010				X							Car Call Below Car
CCCI	F013			X								Car Call Cancel Input Flag
CCD	F00F				X							Car Call Disconnect
CCF	F011						X					Car Call Cancel Flag - Front
CCR	F00C		X									Car Call Cancel Flag - Rear
CCHOLD	F017		X									Car Call Hold
CMC	F010		X									Chicago Fire Memory
CSB	F007		X									Car Stop Bypass Output
CSI	F006						X					Car Select to run on EPI phase 2
CCTF	F016								X			Car Call Door Time - Front
CTL	F01D		X									Car to Lobby
CCTR	F00D			X								Car Call Door Time - Rear
CWI	F006		X									Counterweight Earthquake Input
DBCFC	F005		X									Door Close Pushbutton Front
DBCRC	F000		X									Door Close Pushbutton - Rear
DCC	F015								X			Door Close Complete
DCA	F010						X					Down Call Above the Car
DCB	F010								X			Down Call Below the Car
DCFF	F008	X										Door Close Function Front
DCFR	F00B					X						Door Close Function - Rear
DCLF	F006									X		Door Closed Limit Front
DCLR	F006								X			Door Closed Limit Rear

Name	Address	LED Bank										Description	
		8	4	2	1	8	4	2	1				
DCPF	F008		X										Door Close Power Front
DCPR	F00B							X					Door Close Power - Rear
DCR	F00C				X								Down Call Rear
DDF	F013	X											Double Ding Function
DDP	F016				X								Down Direction Preference
DHLDF	F002									X			Door Hold Input Front
DHLDR	F005				X								Door Hold Input - Rear
DHLDTF	F015				X								Front Door Hold Timer Flag
DHLDTR	F015										X		Rear Door Hold Timer Flag
DHLO	F01E									X			Door Hold Output
DHOF	F017			X									Door Hold Open Front
DHOR	F00D									X			Door Hold Open Rear
DHPO	F01E							X					Door Hold Pre-Expired Output
DIN	F017	X											Door Inactive Flag
DISCF	F01F				X								N.Y. Fire Doors Closing Front
DISCR	F01F			X									N.Y. Fire Doors closing Rear
DSOF	F01F		X										N.Y. Fire Doors Open Front
DRSOK	F01F												N.Y. Fire Doors Open Rear
DLK	F001			X									Door Lock Input
DLYO	F01F												Car Delayed Flashing Output
DMD	F011				X								Demand Down
DMU	F011			X									Demand UP
DN	F003									X			Attendant Down Direction Input
DNS	F001								X				Down Sense
DOBF	F001		X										Door Open Push-button - Front
DOBR	F005			X									Door Open Push-button - Rear
DOIF	F017				X								Door Open Intent Front
DOIR	F00E				X								Door Open Intent - Rear
DOLF	F000	X											Door Open Limit - Front
DOLR	F005	X											Door Open Limit - Rear
DOFF	F007					X							Door Open Function Front
DOFR	F00B	X											Door Open Function - Rear
DOLMF	F015	X											Door Open Limit Front Memory
DOLMR	F015					X							Door Open Limit Rear Memory
DOMF	F012					X							Door Open Memory Front
DOMR	F012			X									Door Open Memory Rear
DOPH2	F010	X											Door Open Phase flag
DPD	F00C									X			Down Previous Direction
DPR	F018			X									Door Protection Timer flag
DSF	F00E			X									Door Time Shortening Flag Front
DSM	F012	X											Chicago Door Button Pressed
DSD1	F002									X			Down Slowdown Switch 1 Input

Name	Address	LED Bank										Description	
		8	4	2	1	8	4	2	1				
DSD2	F003		X										Down Slowdown Switch 2 Input
DSR	F01A					X							Rear Door Shortening flag
DZF	F002			X									Door Zone - Front
DZORDZ	F01A	X											Door Zone Front or Rear
DZR	F005										X		Door Zone - Rear
ECC	F019					X							Excess Car Calls
EDS	F006			X									Earthquake Direction Switch input
EPI	F001										X		Emergency Power Input
EPIM	F00B										X		Emergency Power Memory Flag
EPPT	F01D			X									Emergency Power Pre-Transfer
EPS	F015		X										Emergency Power Selected to Run
EQA	F00E										X		Earthquake Abnormal
EQAM	F00B				X								Earthquake Abnormal memory
EQN	F00E										X		Earthquake Normal
EQS	F00-8			X									Earthquake Output
EQI	F006	X											Earthquake Input
FBP	F01E			X									Fire Bypass Input
FBPM	F01E		X										Fire Bypass Memory
FCS	F002					X							Fire Service Phase 2 Input
FCSM	F015			X									Fire Service Phase 2 Memory
FCSWO	F014		X										Fire Service Phase 2 Was Active
FDCF	F00D							X					Doors Front Fully Closed Phase 2
FDCR	F00C							X					Doors Rear Fully Closed Phase 2
FGED	F008										X		Front Gong Enable Down
FGEU	F008								X				Front Gong Enable Up
FIREMEM	F01B				X								Fire Memory Flag
fireMLT	F01A							X					Fire Service With MLT Operation
fireOUT	F01D					X							Fire Service Output
FON	F01C			X									Fire Service Return Switch Input
FP2	F01E	X											Fire Phase 2 Flag
FRA	F000					X							Alternate Fire Service Input
FRC	F00E							X					Fire Service Phase 2
FRM	F00E						X						Fire Service Phase 1
FRS	F002				X								Main Fire Service Input
FWI	F009	X											Fire Warning Indicator
GHTF	F01A		X										Gong Hold Timer Front
GHTR	F01A				X								Gong Hold Timer Rear
GTDE	F013										X		Gong Timer Down Enable
GTUE	F013									X			Gong Timer Up Enable
H	F017									X			High Speed
HCDX	F01B			X									Hall Call Disconnect
HCR	F00F	X											Hall Call Reject

Name	Address	LED Bank										Description
		8	4	2	1	8	4	2	1			
HCRO	F00A						X					Hall Call Reject Output
HCTF	F016						X					Hall Call Door Time - Front
HCTR	F00D		X									Hall Call Door Time - Rear
HD	F017						X					High Speed Delay
HEWI	F00A					X						Hospital Emergency Indicator
HF1	F01B								X			Machine Room Smoke Detector
HF2	F01B								X			Hoistway Smoke Detector
HI	F017								X			High Intermediate Speed
HIR	F007				X							High Intermediate Speed Output
HLI	F003								X			Heavy Loadweigher Input
HLW	F019								X			Heavy Load Input
HLWO	F018								X			Heavy Load Output
HR	F007			X								High Speed Output
HSEL	F014								X			Hospital Selected Car
HSI	F004								X			Hospital Input
HSR	F013				X							Heat Sensor Input
IDLE	F01D								X			Idle Timeout output
IN	F001	X										Controller Inspection Input
INC	F00F		X									Independent Service Aux. Flag
insACC	F01C							X				Inspection/ Access mode
IND	F000								X			Independent Service Input
insCT	F01C				X							Car Top Inspection
insDN	F01C								X			Inspection Down Direction Input
insINC	F01C					X						In Car Inspection
insUP	F01C								X			Inspection Up Direction Input
ISTD	F003				X							Intermediate Step Down Input
ISTU	F003			X								Intermediate Step Up Input
ISC	F014							X				In Service Capable
ISR	F018							X				In Service & Ready
ISRT	F014				X							Truly in Service
ISV	F00F			X								In Service
LBF	F018					X						Car-At-Lobby
LCD	F014			X								Lobby Car Disable
LD	F01C		X									Leveling Down Input
LFP	F011		X									Lower Floor Parking Intent
LLI	F000				X							Light Loadweigher Input
LLW	F019								X			Light Load
LOIL	F01E								X			Low Oil Input
LRC	F018	X										Lobby Return Call
LRF	F018		X									Lobby Return Function
LSSM	F01F								X			Low Speed Safety Monitor Input
LTF	F016					X						Lobby Door Time Front

Name	Address	LED Bank										Description	
		8	4	2	1	8	4	2	1				
LTR	F00D	X											Lobby Door Time - Rear
lvCSB	F010											X	Car Safety Stop Switch Bypass
fireCSB	F012											X	Car Safety Stop Switch Bypass
LU	F01C	X											Leveling Up Input
LVL	F001											X	Leveling Input
mFIRE	F01B					X							Main Fire Master Flag
MGR/AA	F007	X											M/G Set Run Output
MIS	F012		X										Master In Service Flag
MLT	F010					X							Motor Limit Timer
MPR	F008											X	Microprocessor Running
NDGBPS	F015								X				Nudging Bypass
NDSF	F019	X											Front Hall Door Timer Non-Short.
NDSR	F00C					X							Rear Hall Door Timer Non-Short.
NUDG	F008				X								Nudging
N5B	F004			X									No 50 Buss (Hall Call Common)
OFF	F01D	X											Car Shot Off input
OUTDZ	F01A											X	Car Out of Door Zone Area
PGI	F006					X							Passing Gong Input
PGO	F012				X								Passing Gong Out
PK	F00F					X							Car Parked
PHEF	F002		X										Photo-Eye Input Front
PHER	F005											X	Photo-Eye Input – Rear
PIT	F01D								X				Pit Switch Flag
PITF	F005					X							Not Used
PITI	F01D											X	Pit Switch Input
PRT	F01C	X											Park Release Timer Elapsed
PSTX	F01A			X									STU or STD flags active
PTR	F004	X											Permission to Run (From Group)
PTS	F004		X										Permission to Start (From Group)
REV	F01A											X	Car Reversal Flag
RGED	F00B			X									Rear Gong Enable Down
RGEU	F00B		X										Rear Gong Enable Up
RL	F007											X	Level/Relevel Output
RUN	F017					X							Elevator Run Flag
SAF	F000			X									Primary Safety String Input
SAFM	F00B											X	Safety String Input memory
SALRM	F00A											X	Security Alarm output
SD	F007											X	Down Direction Output
SDA	F009				X								Down Direction Arrow
SDTF	F016											X	Short Door Time Front
SDTR	F00D				X								Short Door Time Rear
SEF	F002	X											Safety Edge Input Front

Name	Address	LED Bank										Description
		8	4	2	1	8	4	2	1			
SELDLY	F014							X				Hospital Select Delay
SER	F005							X				Safety Edge Input - Rear
SPR	F009					X						Stall Protection Timer Expired
SHLD	F014					X						Hospital Select Hold
SHNT	F01D				X							Shunt Trip Input
SSAFM	F01F							X				SDI Safety String Monitor
SSM	F01F							X				Field Safety String Input
STC	F00F								X			Stepping Complete Flag
STCP	F019				X							Stepping Complete Flag Primed
STD	F000								X			Step Down Input
STE	F019		X									High Speed Stepping Error
SQH	F019			X								Fake High Speed for Squelching
STRE	F00E	X										Stop Timer Elapsed
STU	F000							X				Step Up Input
SU	F007							X				Up Direction Output
SUA	F009			X								Up Direction Arrow
TFAF	F011					X						Not Used Flag
TFAR	F00C	X										Not Used Flag
TFD	F00F							X				Top Floor Demand
TFX	F00E		X									Transfer Function
THO	F018				X							Tongue Hanging Out
TOS	F018								X			Timed Out Of Service
TPR	F01B		X									Timer Tick Input
UCF	F011								X			Up Call Cancel Flag Front
UCA	F012							X				Up Call Above the Car
UCB	F012								X			Up Call Below the Car
UCR	F00C			X								Up Call Cancel Flag - Rear
UFQ	F00D					X						Up First Qualifier
UDP	F016			X								Up Direction Preference
UFP	F011	X										Upper Floor Parking
UP	F003					X						Attendant Up direction Selection
UPD	F00C								X			Up Previous Direction
UPS	F001					X						Up Direction Sense
USD1	F002							X				Up Slowdown Switch 1 Input
USD2	F003	X										Up Slowdown Switch 2 Input
WILD	F004								X			Wild Switch Input
XREL	F00D								X			Especial Release from parking
YBP	F013					X						Wye Bypass flag
YRQ	F018								X			Request to Start M/G
85X	F009		X									Fire Service Output