

# PCEC Elevator Softstarters

## Elevator Panel Solution User Manual

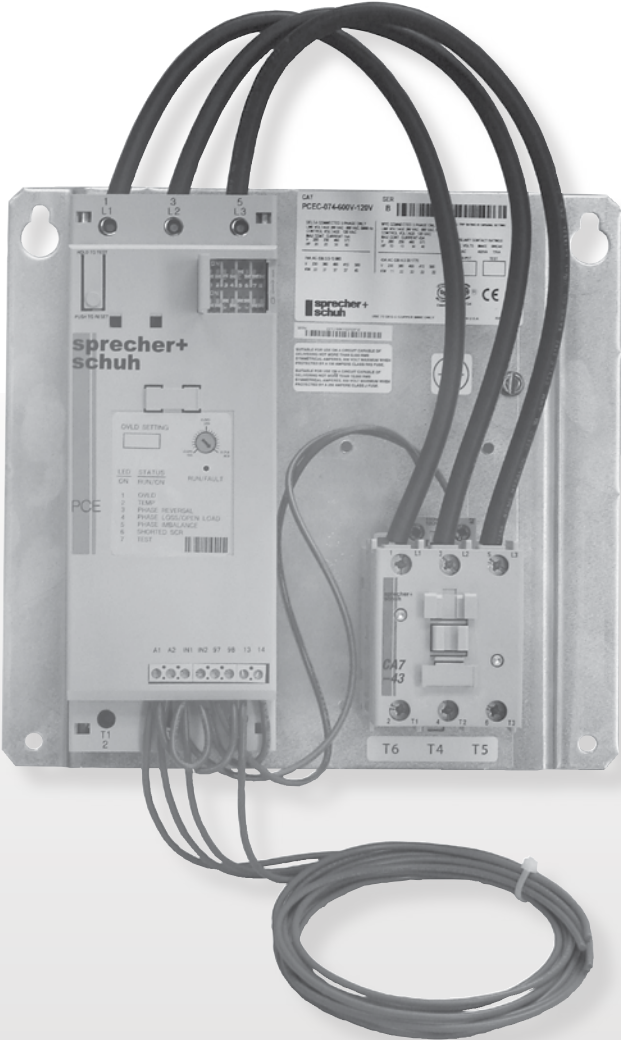

## Important User Information

Because of the variety of uses for the products described in this publication, those responsible for the application and use of this control equipment must satisfy themselves that all necessary steps have been taken to assure that each application and use meets all performance and safety requirements, including any applicable laws, regulations, codes and standards.

The illustrations, charts, sample programs and layout examples shown in this guide are intended solely for purposes of example. Since there are many variables and requirements associated with any particular installation, Sprecher and Schuh does not assume responsibility or liability (to include intellectual property liability) for actual use based upon the examples shown in this publication.

Rockwell Automation publication SGI-1.1, *Safety Guidelines for the Application, Installation and Maintenance of Solid-State Control* (available from your local Sprecher + Schuh office), describes some important differences between solid-state equipment and electromechanical devices that should be taken into consideration when applying products such as those described in this publication.

Reproduction of the contents of this copyrighted publication, in whole or part, without written permission of Rockwell Automation, is prohibited.

Throughout this manual we use notes to make you aware of safety considerations:

---

### Attention



Identifies information about practices or circumstances that can lead to personal injury or death, property damage or economic loss

---

Attention statements help you to:

- identify a hazard
- avoid a hazard
- recognize the consequences

---

### Important

Identifies information that is critical for successful application and understanding of the product.

---

## **European Communities (EC) Directive Compliance**

If this product has the CE mark it is approved for installation within the European Union and EEA regions. It has been designed and tested to meet the following directives.

### **EMC Directive**

This product is tested to meet the Council Directive 89/336/EC Electromagnetic Compatibility (EMC) by applying the following standards, in whole or in part, documented in a technical construction file:

EN 60947-4-2 EMC — Product Standard

This product is intended for use in an industrial environment.

### **Low Voltage Directive**

This product is tested to meet Council Directive 73/23/EEC Low Voltage.

This equipment is classified as open equipment and must be mounted in an enclosure during operation to provide safety protection.

## **UL/CSA Elevator Ratings**

The PCEC Softstarters are UL Listed and cUL Listed (Canadian Standards per UL 508 and CS C22.2 No. 14-95) as solid state motor controllers in File E96956. They are also UL Listed and cUL Listed per UL 508 and CAN/CSA B44.1-96 as elevator controllers in File E3125.

<b>Chapter 1: Introduction</b>	Introduction.....	1-1
	Components Overview.....	1-2
	Function Overview.....	1-3
	Starter Selection .....	1-4
<b>Chapter 2: Installation</b>	Unpacking.....	2-1
	Mounting.....	2-1
	Dimensions Drawings .....	2-1
	Installation Precautions .....	2-3
	Terminal Torque Specifications.....	2-4
	DELTA Connection Diagrams, Power, and Motor Wiring .....	2-5
	LINE Connection Diagrams, Power, and Motor Wiring .....	2-6
	DELTA Connected Controller - Typical Control Wiring.....	2-7
	LINE Connected Controller - Typical Control Wiring.....	2-8
<b>Chapter 3: Programming</b>	Dip Switch Settings.....	3-1
	Motor FLA Adjustments .....	3-3
	Motor Overload Trip Curves .....	3-3
	Input and Output timing.....	3-4
<b>Chapter 4: Troubleshooting</b>	Introduction.....	4-1
	Diagnostics Indication.....	4-2
	Troubleshooting Steps .....	4-3
	Repair Parts Information .....	4-4
<b>Chapter 5: Specifications</b>	Electrical .....	5-1
	Mechanical.....	5-2
	Environmental .....	5-2
<b>Index</b>	Motor Current Rating Chart.....	Index-1

## Introduction

This manual provides an overview of the installation, set-up, and typical operation of the Sprecher + Schuh hydraulic elevator and escalator starter. This solid state starter solution is designed to operate 3 phase standard squirrel cage induction motors and can be connected to a 6 or 12 lead Wye-Delta or standard 3 or 9 lead motors. Through the use of LINE or INSIDE-THE-DELTA control, the solid state solution can provide ultimate control of the motor. The advantages of a solid state solution include the following:

- Provides smooth motor starting
- Reduced current surges on weak electrical systems
- Reduced starting torque of the motor helps to reduce mechanical stress on system components
- Helps meet both local and regional electrical codes when reduced voltage starting is a requirement
- The elimination of the voltage and current spikes associated with traditional Wye-Delta starters
- Maximize the life of the motor with reduced electrical strain
- Reduces general system maintenance requirements for improved uptime

### Components Overview

The starter is made up of two components, the base controller and a fault contactor.

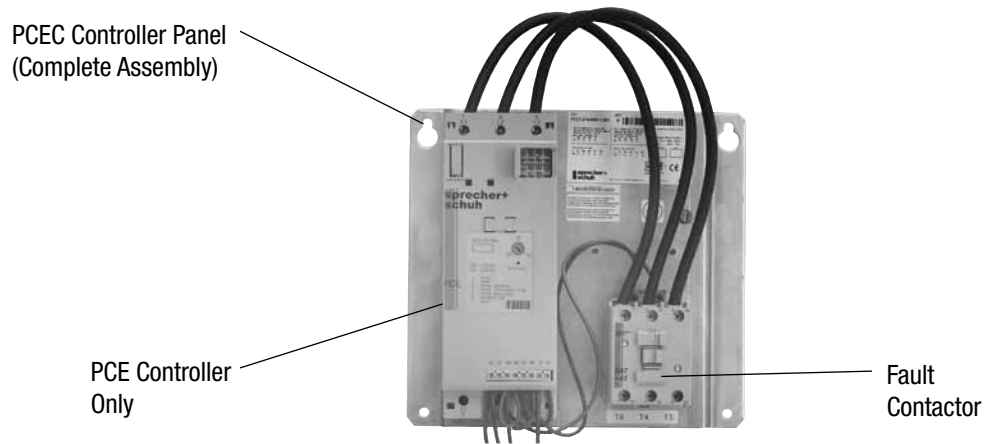

The base controller is a standard product that uses a number of intelligent features to provide advanced motor control and simple diagnostics. The controller consists of the elements necessary to control the motor, including the main micro processor, current sensing, built in adjustable overload, solid state power modules, and electro-mechanical bypass contacts. Through the use of simple dip switch configuration, the product can be configured for a variety of modes. The default configuration uses the built in current sensing to limit current to the motor during starting. Once up to speed the controller transitions to the run mode by transitioning to internal bypass contactors and changing the state of the aux contact. The internal bypass contactor provides decreased heating during run and removes the SCR's from the circuit

The fault contactor is controlled through the fault contact of the controller. When control power is applied to the controller, the normally open fault contact closes and applies control power to the coil of the contactor. The fault contact will open removing power from the fault contactor, and thus disabling the motor during any one of the following events:

- Power is removed from the controller
- The motor has developed a problem including overloading due to mechanical or electrical reasons, ground faults, or motor short circuits.
- If the starter would detect an internal problem such as a shorted SCR or Overtemp condition

## Function Overview

This PCEC elevator panel solution provides both advanced motor control and simple diagnostics. The following information provides a brief overview of the basic product features.

### Motor Control

#### *Current Limit*

Through the use of internal current sensors, the PCEC will regulate the current level applied to the motor over the programmed period of time. This type of motor control produces a slow start and insures that the current does not exceed the programmed level. This is standard configuration of the device and aligns well with traditional applications.

#### *Soft Start*

During Soft start, the voltage is ramped from an initial set point to full voltage over the programmed period of time. This type of motor control produces a smooth start in less time than the current limit setting, however the current is not restricted.

#### *Soft Stop*

Soft stop provides the ability to ramp down the voltage applied to the motor over a programmed period of time. The result is a smooth stop.

### Diagnostics

#### *Overload*

The built in motor overload provides protection of the motor for over current conditions. This protection feature offers a user selectable setting called the trip class, which can be used to accommodate different applications and motor types. When the motor draws more than the nominal value of current for a period of time, the device will fault on a motor overload fault.

#### *Over Temperature*

The product includes a built in self monitoring method for detecting a SCR over-temperature condition. If the internal temperature exceeds a design threshold the device will fault on a SCR Overtemp fault.

#### *Phase Reversal*

The user can select the phase relationship of the incoming power. If this phase relationship changes, the device will fault indicating a problem.

#### *Phase Loss/ Open Load*

When any one of the incoming 3 phases are lost, the controller will fault indicating a phase loss condition has occurred.

#### *Phase Imbalance*

When enabled, this motor protection feature will detect if a phase imbalance condition exists and fault the unit. A phase imbalance is defined as a 65% differential between the highest and lowest phase for more than 3 seconds.

#### *Shorted SCR*

Each time the PCEC initiates a start, it checks to see if the SCR's are operating correctly. If the controller is unable to properly turn on and off any one of the SCR's, the device will fault on a Shorted SCR fault.

## Starter Selection; Starters for use with Wye-Delta Wound Motors

Table 1 lists the catalog numbers that can be used with 6 or 12 lead Wye-Delta motors. For proper operation the connection should be verified during installation. Sample connection diagrams for INSIDE-THE-DELTA connected motors are included in the installation and wiring section found later in this manual.

**Table 1 - Starter Ratings for 6 or 12 lead Wye-Delta wound Motors**

HP @ nominal ratings				Overload Range*	Catalog Numbers	
200V	240V	480V	575V		120V Control Voltage	230V Control Voltage
10	10	20	30	10.9...32.9	PCEC-032-600V-120V	PCEC-032-600V-230V
15	15	30	40	17...51	PCEC-051-600V-120V	PCEC-051-600V-230V
20	20	40	60	21.3...64	PCEC-064-600V-120V	PCEC-064-600V-230V
20	25	50	60	24.7...74	PCEC-074-600V-120V	PCEC-074-600V-230V
30	40	75	100	34.7...104	PCEC-104-600V-120V	PCEC-104-600V-230V
40	50	100	150	49...147	PCEC-147-600V-120V	PCEC-147-600V-230V
75	75	150	200	59...234	PCEC-234-600V-120V	PCEC-234-600V-230V

\* Motor FLA must fall within the specified range to operate correctly

Table 2 lists the catalog numbers that can be used with 3 or 9 lead closed delta type motors. For proper operation the connection should be verified during installation. Sample connection diagrams for LINE connected motors are included in the installation and wiring section found later in this manual.

**Table 2 - Starter Ratings for 3 or 9 lead Delta Motors (see Important Note)**

HP @ nominal ratings				Overload Range*	Catalog Numbers	
200V	240V	480V	575V		120V Control Voltage	230V Control Voltage
5	5	10	15	6.3...19	PCEC-032-600V-120V	PCEC-032-600V-230V
7.5	10	20	25	10...30	PCEC-051-600V-120V	PCEC-051-600V-230V
10	10	25	30	12.3...37	PCEC-064-600V-120V	PCEC-064-600V-230V
10	15	30	40	14.3...43	PCEC-074-600V-120V	PCEC-074-600V-230V
15	20	40	50	20...60	PCEC-104-600V-120V	PCEC-104-600V-230V
25	30	60	75	28.3...85	PCEC-147-600V-120V	PCEC-147-600V-230V
40	50	100	125	34...135	PCEC-234-600V-120V	PCEC-234-600V-230V

\* Motor FLA must fall within the specified range to operate correctly

## Important Note

The elevator panels are shipped in the DELTA connection mode by default. LINE connection requires that the power wires be reconfigured and Dip Switch#15 be programmed for LINE connection mode.



### Unpacking

Prior to installation, unpack the starter panel from its packaging and perform a complete visual inspection of panel. Inspect all components including the controller, wiring, and fault contactor for damage related to shipping and handling. Claims for damage must be made to the carrier as soon as possible after receipt of the shipment.

### Mounting

The small footprint of the starter makes it ideal for mounting in the same space previously occupied by legacy solid state starters and traditional Full Voltage starters. The starter panel does not require mounting requirements beyond the basic footprint of the panel.

The product incorporates a small cooling fan. There are no additional cooling requirements for the product; however it is good practice to leave at least 6 inches (15.24 cm) of free space above and below the unit for ideal air flow.

### Dimensions Drawings

**Figure 1 – Panel Dimensions for 32, 51, and 64 Amp Elevator Panels**

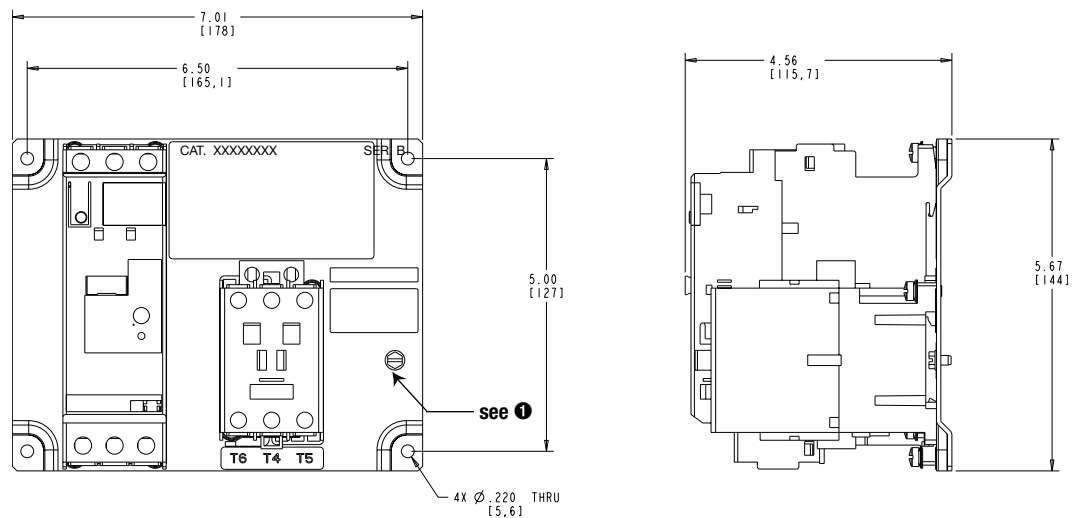

Dimensions in mm (in)  
Weight 4lbs (2kg)

❶ This screw is intended for securing: a) a prepared bonding conductor (such as one with crimped-on lug); or b) a suitable terminal for connection of an unprepared bonding conductor (stripped wire end). This screw is not intended for direct field wiring connection of an unprepared conductor or equipment grounding conductor.

**Figure 2 – Panel Dimensions for 74, 104, and 147 Amp Elevator Panels**

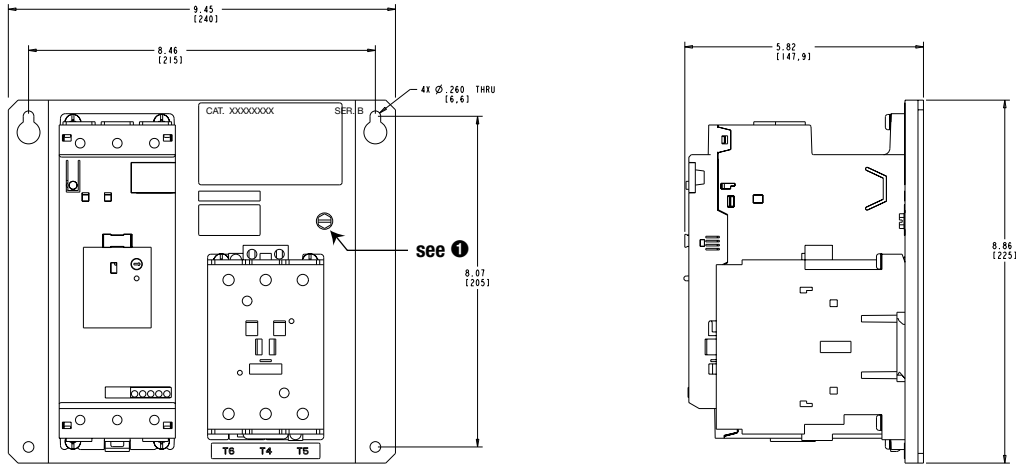

Dimensions in mm (in)  
Weight 14lbs (6kg)

**Figure 3 - Panel Dimensions for 234 Amp Elevator Panels**

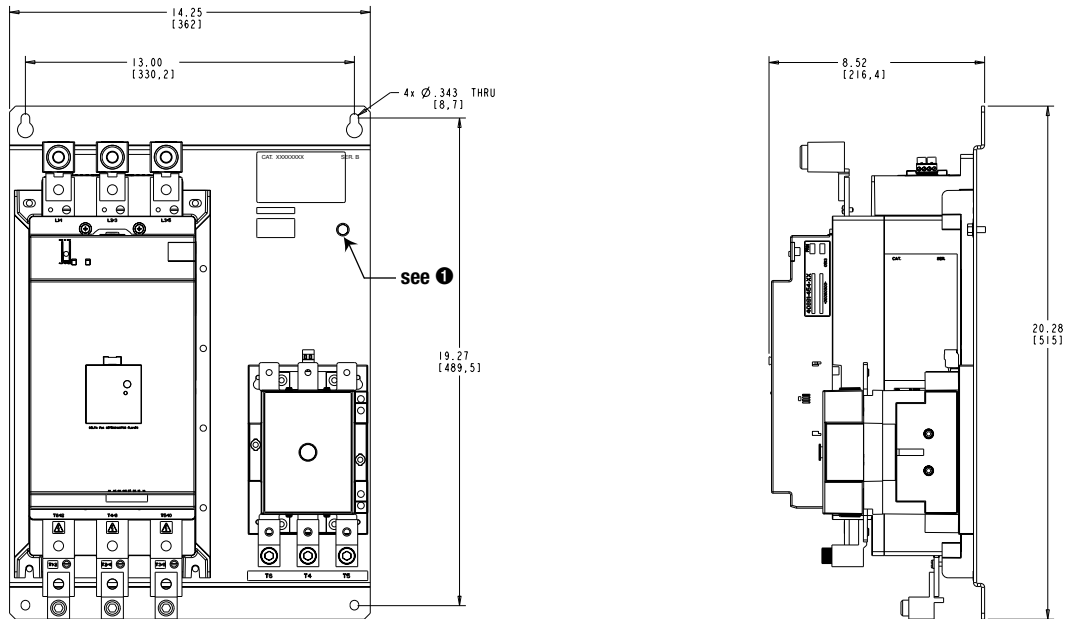

Dimensions in mm (in)  
Weight 51lbs (23kg)

❶ This screw is intended for securing: a) a prepared bonding conductor (such as one with crimped-on lug); or b) a suitable terminal for connection of an unprepared bonding conductor (stripped wire end). This screw is not intended for direct field wiring connection of an unprepared conductor or equipment grounding conductor.

### Installation Precautions

The following installation considerations are provided as guidance for proper installation of this controller. Due to the nature of this product, it may be applied in a variety of applications so not all considerations may be applicable to a particular application. In all cases, the local codes and standards governing this type of product must be observed.

- Motor Branch Protection and Disconnecting Means
  - ◆ The controller includes motor overload protection; however it does not have means to protect itself from a short circuit condition. Suitable branch circuit protection and coordination must be provided per the NEC, or the equivalent local electrical code.
  
- Electrical Noise Suppression
  - ◆ Electrical noise can be generated from various sources connected to the same power as the controller. Sources of noise include inductive loads (i.e. relays and solenoids), large motors and machinery, Variable Frequency Drives, and other high frequency devices (i.e. welders)
  - ◆ Electrical noise can enter the product through power and control wiring and cause damage to solid state components.
  - ◆ Mitigation of electrical noise can be accomplished through the following methods
    - Proper wiring practices including grounding, use of shielded cable where appropriate, and separation of power, control, and signaling wires
    - Use of surge suppression devices on inductive loads
    - Use of isolation transformers for high frequency generators
  
- Power Factor Correction Capacitors (PFCC)
  - ◆ Power Factor correction capacitors must always be used line side of the controller. Use of PFCC's on the output side of the controller will damage the starter.

### Terminal Torque Specifications

**Table 3 - PCE Controller Information**

Controller Size	Units	Line Power Terminals	Load Power Terminals	Control Power Terminals
32/51/64	Wire Size	14 - 4 AWG (2.5 - 25 mm <sup>2</sup> )	14 - 6 AWG (2.5 - 16 mm <sup>2</sup> )	24 - 14 AWG (0.2 - 2.5 mm <sup>2</sup> )
	Torque	20 - 25 lb-in. (2.3 - 2.8 Nm)	20 - 22.5 lb-in. (2.3 - 2.6 Nm)	4.4 - 8 lb-in. (0.5 - 0.9 Nm)
74/104/147	Wire Size	14 - 3/0 AWG (2.5 - 95 mm <sup>2</sup> )	14 - 1 AWG (2.5 - 50 mm <sup>2</sup> )	24 - 14 AWG (0.2 - 2.5 mm <sup>2</sup> )
	Torque	100 - 110 lb-in. (11.3 - 12.4 Nm)	100 - 110 lb-in. (11.3 - 12.4 Nm)	4.4 - 8 lb-in. (0.5 - 0.9 Nm)
234	Wire Size	6 - 250 AWG (16 - 120 mm <sup>2</sup> )	6 - 250 AWG (16 - 120 mm <sup>2</sup> )	24 - 14 AWG (0.2 - 2.5 mm <sup>2</sup> )
	Torque	275 lb-in. (31 Nm)	275 lb-in. (31 Nm)	4.4 - 8 lb-in. (0.5 - 0.9 Nm)

**Table 4 - Fault Contactor Information**

Controller Size	Units	Line Power Terminals	Load Power Terminals	Control Power Terminals
32/51/64/74	Wire Size	14 - 4 AWG (2.5 - 16 mm <sup>2</sup> )	14 - 4 AWG (2.5 - 16 mm <sup>2</sup> )	16 - 12 AWG (1.5 - 6 mm <sup>2</sup> )
	Torque	22 - 35 lb. in. (2.5 - 4 Nm)	22 - 35 lb. in. (2.5 - 4 Nm)	9 - 13 lb. in. (1 - 2.5 Nm)
104/147	Wire Size	14 - 1 AWG (2.5 - 35 mm <sup>2</sup> )	14 - 1 AWG (2.5 - 35 mm <sup>2</sup> )	16 - 12 AWG (1.5 - 6 mm <sup>2</sup> )
	Torque	31 - 53 lb. in. (3.5 - 6 Nm)	31 - 53 lb. in. (3.5 - 6 Nm)	9 - 13 lb. in. (1 - 2.5 Nm)
234	Wire Size	6 - 300 AWG (16 - 150 mm <sup>2</sup> )	6 - 300 AWG (16 - 150 mm <sup>2</sup> )	2x 16...12 AWG (2x 1...4 mm <sup>2</sup> )
	Torque	250 lb-in. (28 Nm)	250 lb-in. (28 Nm)	12 - 20 lb-in. (1.4 - 2.3 Nm)

## DELTA Connection Diagrams, Power, and Motor Wiring

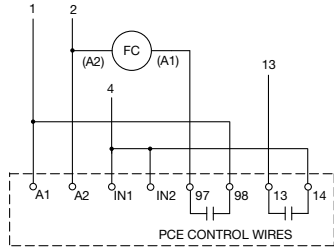

- 1- CONTROL POWER (L)
- 2- CONTROL COMMON (N)
- 4- START ENABLE
- 13- UP TO SPEED INDICATION

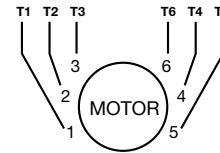
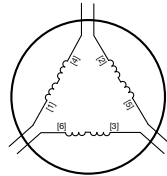
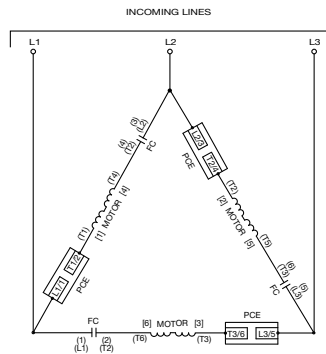
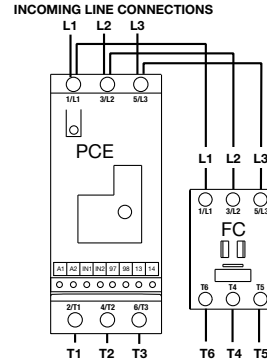
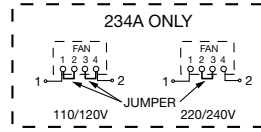

6 LEAD MOTOR CONNECTIONS							
STARTER TERMINALS	T1	T2	T3	T6	T4	T5	JUMPER
MOTOR TERMINALS	1&7	2&8	3&9	6&12	4&10	5&11	N/A

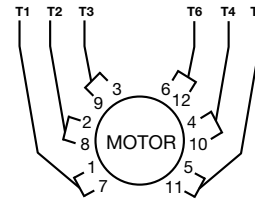
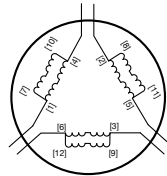
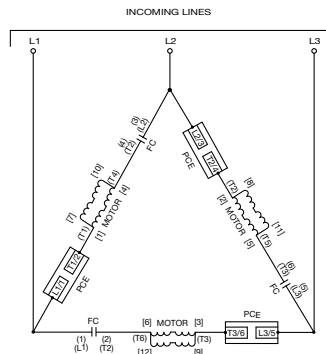

12 LEAD 230V LOW VOLTAGE MOTOR CONNECTIONS							
STARTER TERMINALS	T1	T2	T3	T6	T4	T5	JUMPER
MOTOR TERMINALS	1&7	2&8	3&9	6&12	4&10	5&11	N/A

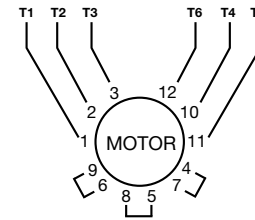
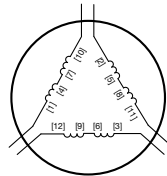
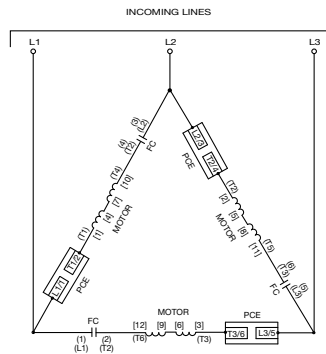

12 LEAD 460V HIGH VOLTAGE MOTOR CONNECTIONS							
STARTER TERMINALS	T1	T2	T3	T6	T4	T5	JUMPER
MOTOR TERMINALS	1	2	3	12	10	11	4&7 5&8 6&9

## LINE Connection Diagrams, Power, and Motor Wiring

- **Note: The power wire configuration and dip switch settings must be changed for the line connection method**

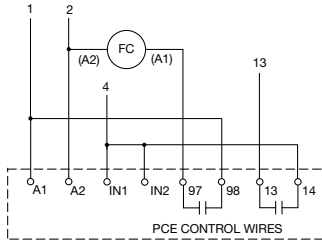

- 1- CONTROL POWER (L)
- 2- CONTROL COMMON (N)
- 4- START ENABLE
- 13- UP TO SPEED INDICATION

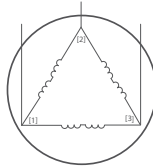
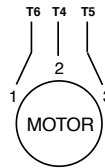
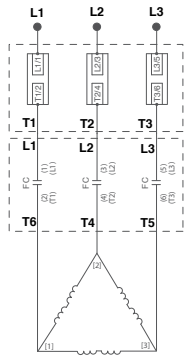
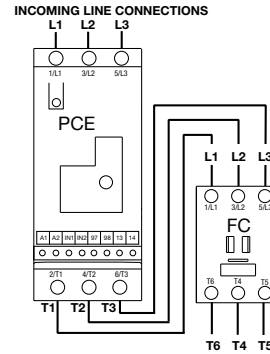
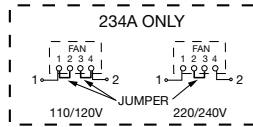

3 LEAD MOTOR CONNECTIONS				
STARTER TERMINALS	T6	T4	T5	JUMPER
MOTOR TERMINALS	1	2	3	N/A

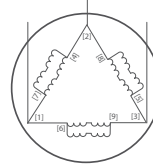
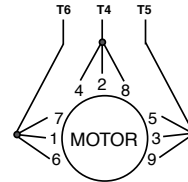
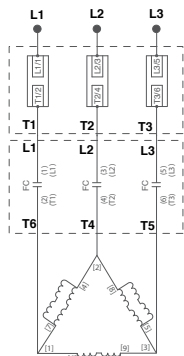

9 LEAD 230V LOW VOLTAGE MOTOR CONNECTIONS				
STARTER TERMINALS	T6	T4	T5	JUMPER
MOTOR TERMINALS	1,6,7	2,4,8	3,5,9	N/A

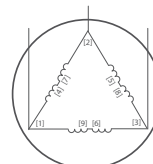
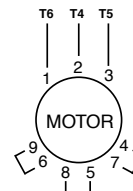
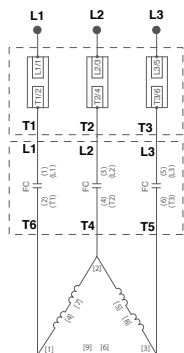

9 LEAD 460V HIGH VOLTAGE MOTOR CONNECTIONS				
STARTER TERMINALS	T6	T4	T5	JUMPER
MOTOR TERMINALS	1	2	3	4&7 5&8 6&9

DELTA Connected Controller - Typical Control Wiring

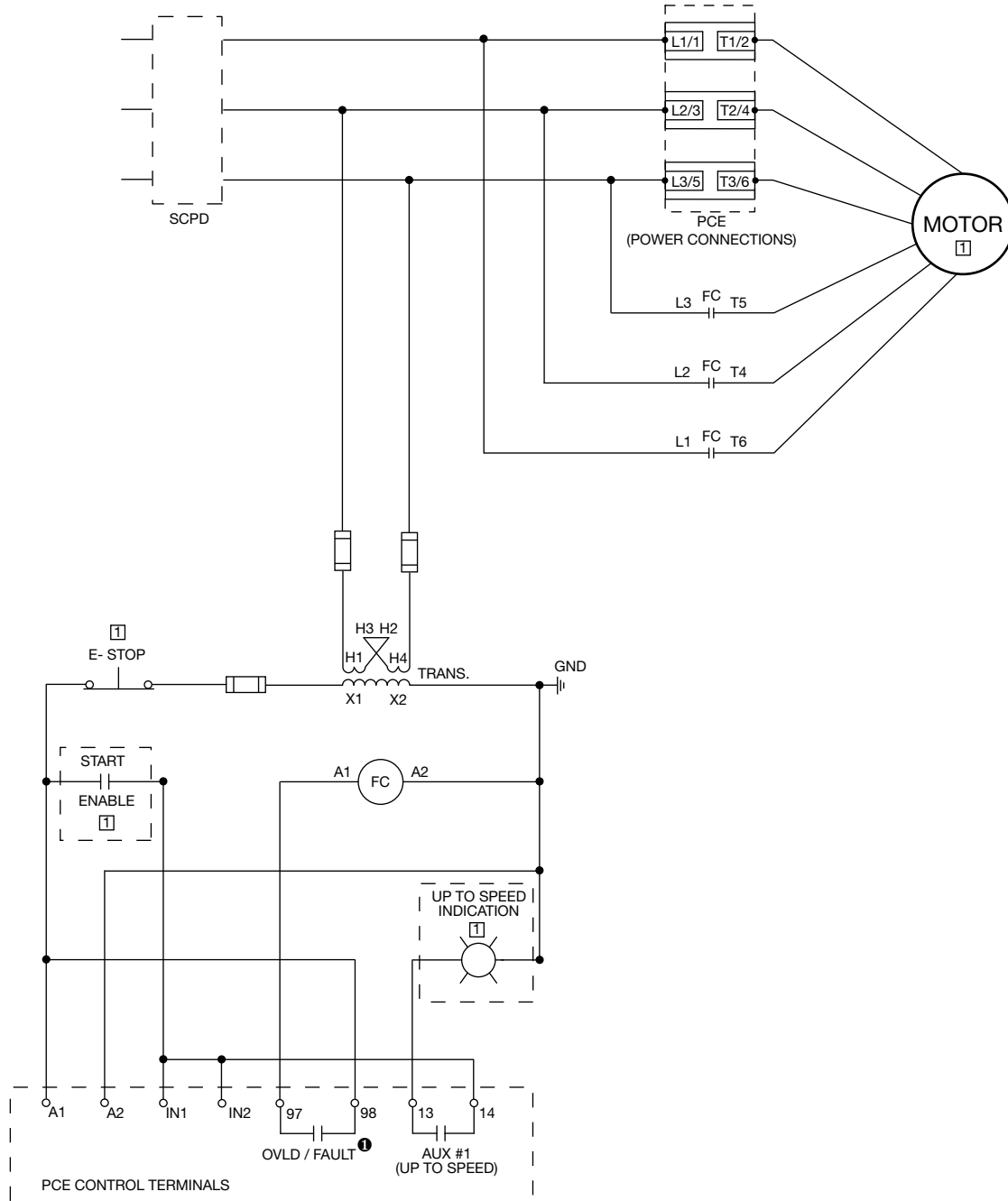

❶ When (A1)(A2) control power is applied, (97)(98) contact closes instantaneously and opens when the PCE detects an overload or fault condition, or when control power is removed.

## LINE Connected Controller - Typical Control Wiring

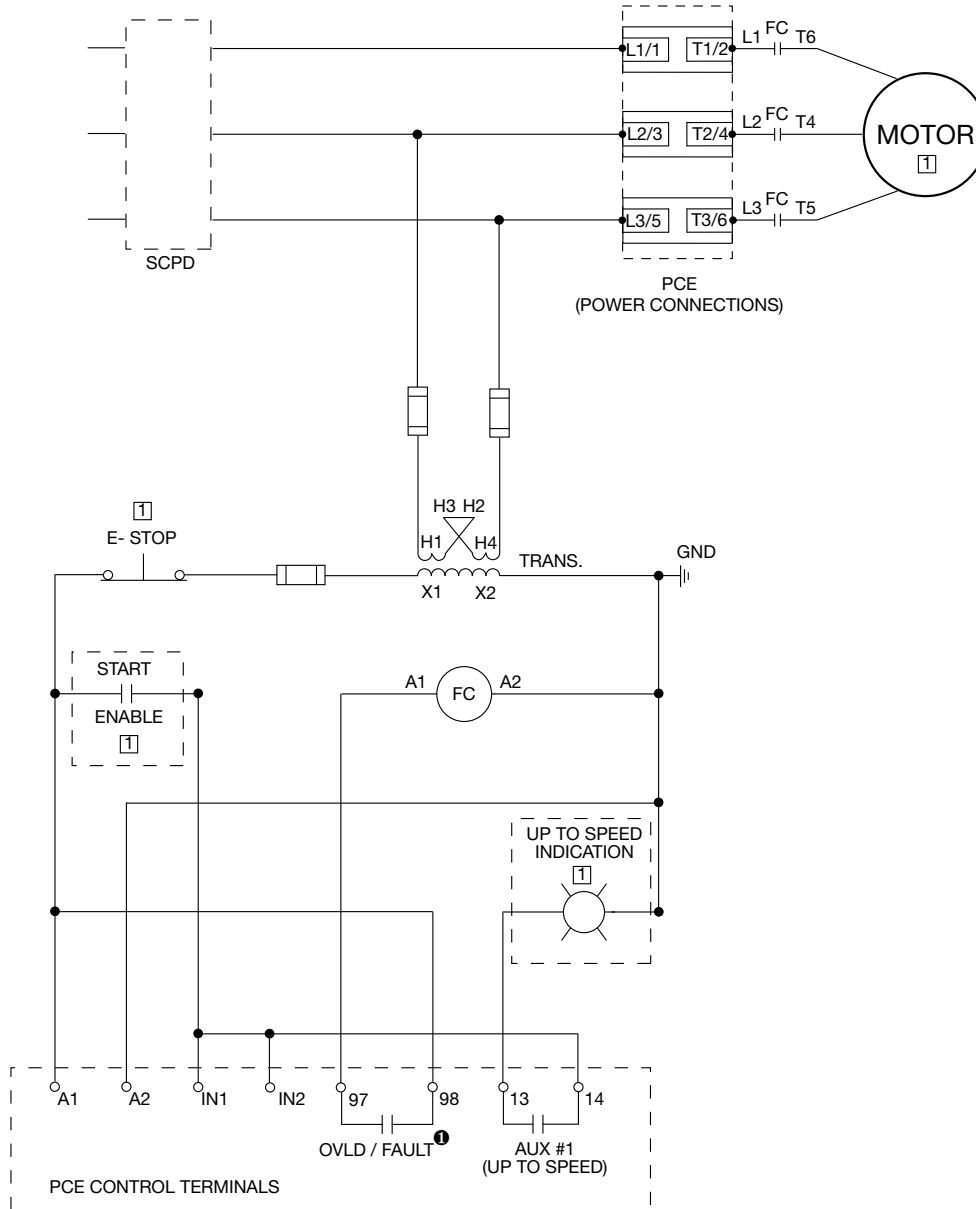

① When (A1)(A2) control power is applied, (97)(98) contact closes instantaneously and opens when the PCE detects an overload or fault condition, or when control power is removed.



## Dip Switch Settings

The PCE elevator controller is programmed through dipswitches located on the front of the controller. All functionality is defined by these settings. The following tables define the settings available within the PCE controller. **Default settings are indicated by the shaded areas.**

**Table 5 - Start Time**

Setting (Seconds)	DIP Switch #1	DIP Switch #2	DIP Switch #8	This defines the time the controller will ramp or limit current to the motor. The controller can determine when the motor is 'up-to-speed', therefore it may transition to bypass before this time expires. If the motor does not reach speed before the time expires, the controller will continue under SCR control and not close the bypass contactor.
2	OFF	OFF	OFF	
5	ON	OFF	OFF	
10	OFF	ON	OFF	
15	ON	ON	OFF	

**Table 6 - Start Mode**

Mode Setting	DIP Switch #3	In Current Limit mode, a set level of current is applied to the motor over the start time. In Soft Start mode, the device will ramp the torque from the initial level to 100% over the start time.
Current Limit	OFF	
Soft Start	ON	

**Table 7 - Current Limit / Initial Torque Level**

%FLA / % Torque	DIP Switch #4	DIP Switch #5	The level indicated by this programming applies an initial level of current or torque to the motor for the start time. For example if switch #3 is set to off, the device will perform a current limit start at the level indicated by these switches.
150% / 15%	OFF	OFF	
250% / 25%	ON	OFF	
350% / 35%	OFF	ON	
450% / 65%	ON	ON	

**Table 8 - Soft Stop Time**

Setting (Seconds)	DIP Switch #6	DIP Switch #7	Soft Stop reduces the voltage applied to the motor over the programmed period of time. The soft stop is complete when the soft stop timer has expired or the current measured drops below 50% of the FLA setting.
OFF	OFF	OFF	
1 x Start Time	ON	OFF	
2 x Start Time	OFF	ON	
3 x Start Time	ON	ON	

**Table 9 - Phase Rotation**

Setting	DIP Switch #9	The allowable phase rotation of the motor is defined by this switch.
ABC Rotation	OFF	
CBA Rotation	ON	

**Table 10 - Phase Imbalance**

Setting	DIP Switch #10	The controller has the ability to monitor for imbalance between phase currents. This protection feature can be user disabled.
Enabled	OFF	
Disabled	ON	

**Table 11 - Overload Trip Class**

Setting	DIP Switch #11	DIP Switch #12	The controller incorporates, as standard, electronic overload protection. This motor overload protection is accomplished electronically with the use of internal current transformers on each of the three phases. The controller's overload protection is programmable, providing the user with flexibility.
OFF	OFF	OFF	
10	ON	OFF	
15	OFF	ON	
20	ON	ON	

**Table 12 - Overload Reset**

Setting	DIP Switch #13	In manual reset mode, the fault can only be reset by pushing the 'push to reset' button on the front of the controller. In auto reset mode, the unit will automatically reset when unit determines the motor has cooled to 75% of its thermal capacity.
Manual	OFF	
Auto	ON	

**Table 13 - Aux#1 Setting**

Setting	DIP Switch #14	The operation defines the operation of the Auxiliary contacts. Normal mode means that the contact will change state immediately when a start/run command is given. Up-to-Speed mode means that the contact will change state only when the controller is in bypass. Aux#2 when added will operate opposite of this programming.
Normal	OFF	
Up-to-Speed	ON	

**Table 14 - Motor Connection Type**

Setting	DIP Switch #15	In DELTA connection mode, the device is designed to control a 6 or 12 lead motor. In LINE connection mode, the device is designed to control a 3 or 9 lead motor.
Delta	OFF	
Line	ON	

**Table 15 - Stop Delay**

Setting	DIP Switch #16	When the delay is programmed, the motor will continue to run for the programmed period of time after the run command is removed from the controller.
0.0 Sec	OFF	
0.75 Sec	ON	

**Motor FLA Adjustments**

The front of the PCE controller contains a dial which is used for setting the actual FLA of the motor. The label is designed to accommodate motors connected in the LINE or DELTA mode. To determine the proper setting, look at the motors nameplate and set the dial accordingly. The dial setting can be modified depending on the service factor of the motor as follows:

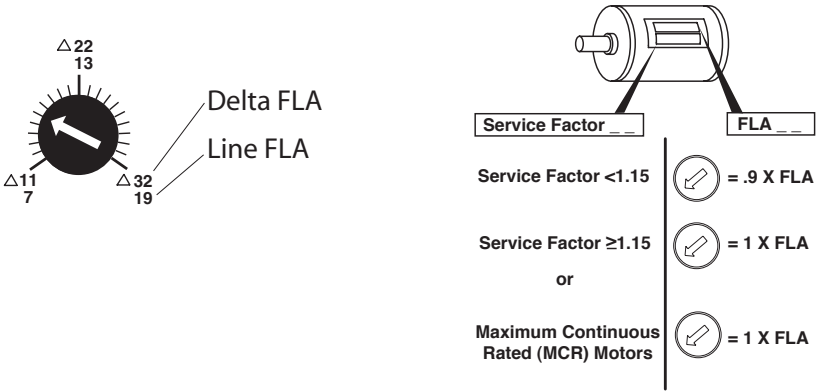

**Motor Overload Trip Curves**

The trip class should be set according to the motors maximum permissible locked rotor time or the general thermal capabilities. Consult the motor manufacturer for recommendations on setting the trip class.

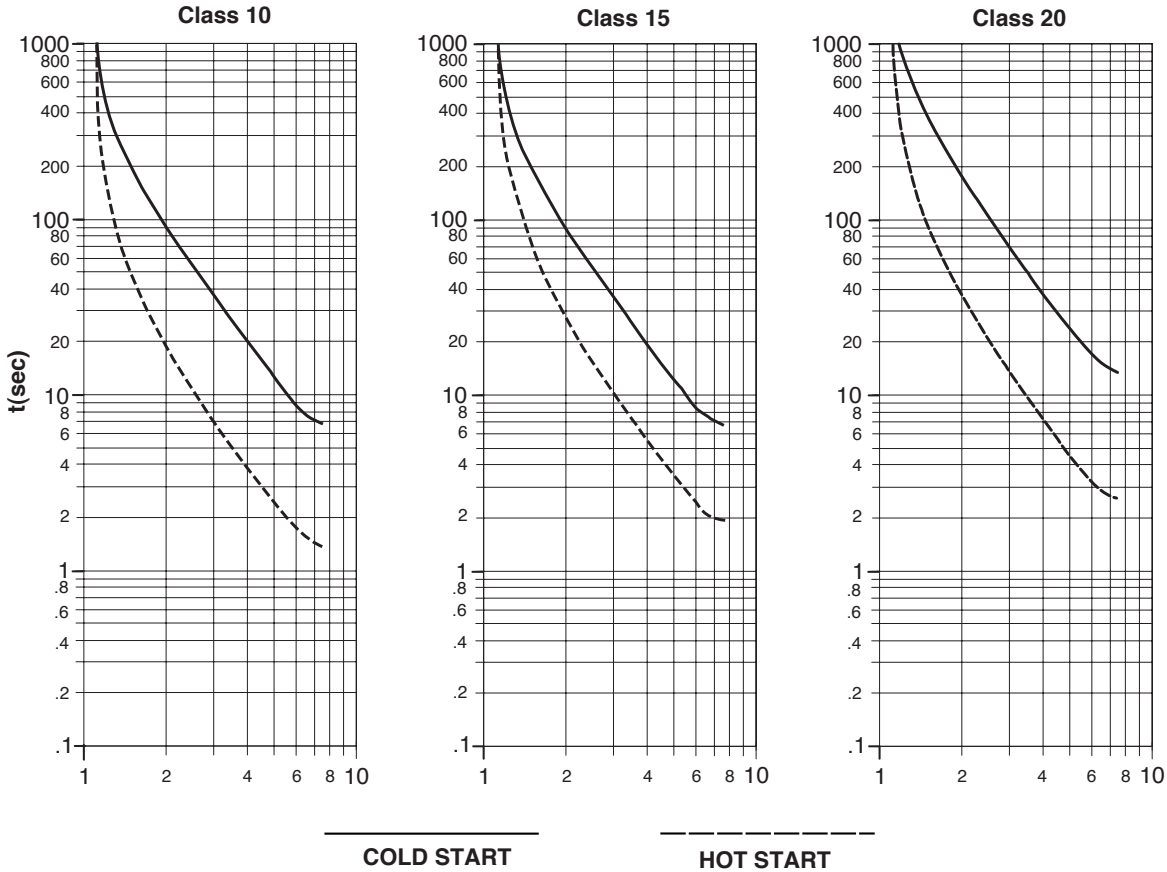

## Input and Output timing

Basic Timing Diagram, No Soft Stop

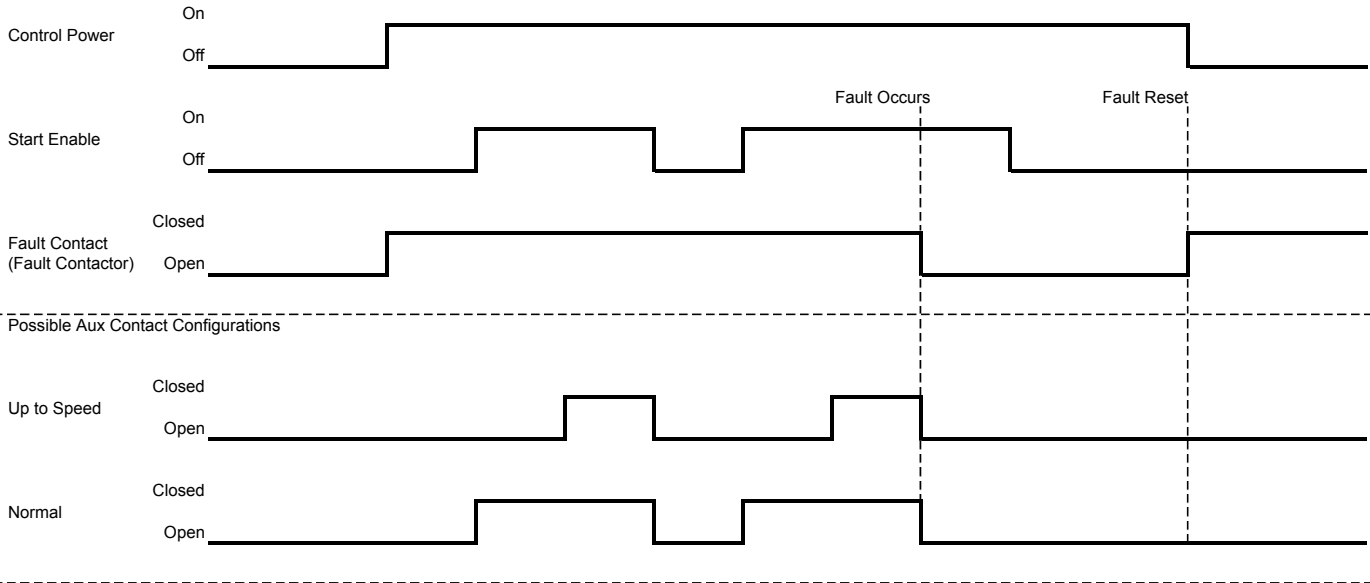

### Introduction

The following topics are designed to assist in the troubleshooting and maintenance of the PCEC controller. The items mentioned in this section are not intended to be all inclusive and it is expected that they should be used as reference only.

For safety of maintenance personnel as well as others who might be exposed to electrical hazards associated with maintenance activities, follow the local safety related work practices (for example, the NFPA 70E, Part II in the United States). Maintenance personnel must be trained in the safety practices, procedures, and requirements that pertain to their respective job assignments.

---

**Attention**

Hazardous voltage is present in the motor circuit even when the PCEC Softstarter is off. To avoid shock hazard, disconnect main power before working on the controller, motor, and control devices such as Start-Stop push buttons. Procedures that require parts of the equipment to be energized during troubleshooting, testing, etc., must be performed by properly qualified personnel, using appropriate local safety work practices and precautionary measures.

**Attention**

Disconnect the controller from the motor before measuring insulation resistance (IR) of the motor windings. Voltages used for insulation resistance testing can cause SCR failure. Do not make any measurements on the controller with an IR tester (megger).

---

Note: The time it takes for the motor to come up to speed may be more or less than the time programmed, depending on the frictional and inertial characteristics of the connected load.

### Diagnostics Indication

The LED on the front of the product provides limited status information regarding the condition of the controller. The conditions are as follows:

- LED Off – No control power or start command given
- LED On – The device is active with starting, running, or stopping.
- LED Flashes- A fault has been experienced, see table 16 for additional explanation.

**Table 16 - Led Fault Indication and Diagnostics**

Flashes	Fault Type	Possible Fault Explanations	Possible Solutions
1	Overload	<ul style="list-style-type: none"> <li>• Motor Overload condition present</li> <li>• FLA dial adjustment not matched to motor</li> </ul>	<ul style="list-style-type: none"> <li>• Check for motor overload condition</li> <li>• Verify actual motor current does not exceed FLA</li> <li>• Verify/Reset FLA Dial adjustment</li> <li>• Program/modify Overload setting for load or duty cycle required</li> </ul>
2	Over Temperature	<ul style="list-style-type: none"> <li>• Controller ventilation blocked</li> <li>• Controller duty cycle exceeded</li> <li>• Cooling fan not working</li> <li>• Ambient temperature exceeded</li> <li>• Failed control module</li> <li>• Over-current condition with Overload disabled</li> </ul>	<ul style="list-style-type: none"> <li>• Check for proper ventilation</li> <li>• Verify duty cycle</li> <li>• Connect or replace cooling fan</li> <li>• Wait for controller to cool or provide external cooling</li> <li>• Replace control module</li> </ul>
3	Phase Reversal	<ul style="list-style-type: none"> <li>• Incoming supply voltage is not the expected sequence of either ABC or CBA</li> </ul>	<ul style="list-style-type: none"> <li>• Check power wiring</li> <li>• Change two of the incoming phases and verify that the motor is spinning in the correct direction. If the motor does not turn in the correct direction, change the incoming phases back to their original connections and change dip switch #9 to the desired Line Rotation sequence setting.</li> </ul>
4	Phase Loss/ Open Load	<ul style="list-style-type: none"> <li>• Missing Supply Phase</li> <li>• Missing or unable to detect motor connection</li> </ul>	<ul style="list-style-type: none"> <li>• Check for open line (i.e. open fuse)</li> <li>• Check for incorrect wiring to load</li> <li>• Verify proper operation of the fault contactor</li> <li>• Verify connection type to motor (LINE or DELTA)</li> <li>• Ensure product is sized correctly for motor</li> </ul>
5	Phase Imbalance	<ul style="list-style-type: none"> <li>• Unbalanced Phase Currents (&gt; 65% differential)</li> <li>• Incoming Line voltage problem</li> </ul>	<ul style="list-style-type: none"> <li>• Check motor current in each phase to verify imbalance. Motor current imbalance can indicate potential motor problems</li> </ul>
6	Shorted SCR	<ul style="list-style-type: none"> <li>• Shorted SCR</li> <li>• Welded or latched Bypass contactor</li> </ul>	<ul style="list-style-type: none"> <li>• Verify connection type (LINE or DELTA) and verify setting</li> <li>• Perform continuity check across power poles (L1 – T1, L2 – T2, L3 – T3). Measurements should exceed 10 k ohms. For best results remove line and load motor connections.</li> <li>• Cycle power to device and attempt to restart, if fault persists replace device</li> </ul>
7	Test	<ul style="list-style-type: none"> <li>• Intended operation</li> </ul>	<ul style="list-style-type: none"> <li>• Reset Fault</li> </ul>
12	Checksum	<ul style="list-style-type: none"> <li>• Internal Software corruption</li> </ul>	<ul style="list-style-type: none"> <li>• Replace Device</li> </ul>

## Troubleshooting Steps

**Table 17 - Troubleshooting Steps**

Control	Device Status	Solution
Pre-start - no start command given but device is faulted	LED Flashing	<ul style="list-style-type: none"> <li>• Reset Fault</li> <li>• Allow device to cool (overload or SCR over temp), Reset Fault</li> <li>• Cycle power to device</li> </ul>
Motor fails to start after start command given	LED Off	<ul style="list-style-type: none"> <li>• Check Control Power</li> <li>• Check control circuit connections</li> </ul>
	LED ON	<ul style="list-style-type: none"> <li>• Verify proper operation of fault contactor or isolation devices</li> <li>• Check connections to the motor</li> <li>• Verify line power and frequency are within specifications</li> </ul>
	LED Flashing	<ul style="list-style-type: none"> <li>• Reference Table 16 for information related to specific fault codes</li> </ul>
Motor Attempts to start after start command is given but fails to reach an up to speed condition	LED ON	<ul style="list-style-type: none"> <li>• Verify proper operation of fault contactor or isolation devices</li> <li>• Verify line power and frequency are within specifications</li> <li>• Try increasing the initial torque or current limit setting</li> </ul>
	LED Flashing	<ul style="list-style-type: none"> <li>• Reference Table 16 for information related to specific fault codes</li> </ul>
Motor Stops abruptly and fails to restart	LED Off	<ul style="list-style-type: none"> <li>• Check for blown fuse or tripped circuit breaker</li> <li>• Insure control power and start command are present</li> <li>• Verify proper operation of fault contactor or isolation devices</li> </ul>
	LED ON	<ul style="list-style-type: none"> <li>• Verify proper operation of fault contactor or isolation devices</li> </ul>
	LED Flashing	<ul style="list-style-type: none"> <li>• Reference Table 16 for information related to specific fault codes</li> </ul>
Fault Contactor Fails to close when power is applied	All Conditions	<ul style="list-style-type: none"> <li>• Verify wiring to coil ( the contactor should close when power is applied to the controller)</li> <li>• Verify voltage across coil (A1 to A2)</li> <li>• Check resistance of coil, replace if measured open</li> <li>• Verify internal contact of controller (terminals 97/98) are properly changing state, replace controller if contact does not operate correctly</li> </ul>

### Repair Parts Information

Panel	Controller		Contactors	Fans	Contactors Coil
PCEC-032-600V-120V	PCE-032-600V		CA7-37-00-120	(Optional) PCV-064	TC473
PCEC-051-600V-120V	PCE-051-600V		CA7-37-00-120		
PCEC-064-600V-120V	PCE-064-600V		CA7-37-00-120		
PCEC-074-600V-120V	PCE-074-600V		CA7-43-00-120	PCV-147	TD473
PCEC-104-600V-120V	PCE-104-600V		CA7-60-00-120		TE473
PCEC-147-600V-120V	PCE-147-600V		CA7-85-00-120		TE473
PCEC-234-600V-120V	Complete Device	PCE-234-600V	CA6-180-EI-11-120	PCV-234	CA6-TGE865
	Control Module	PCE-234			
	Power Pole	PCL-0135			

PCEC-032-600V-230V	PCE-032-600V		CA7-37-00-240	(Optional) PCV-064	TC296
PCEC-051-600V-230V	PCE-051-600V		CA7-37-00-240		
PCEC-064-600V-230V	PCE-064-600V		CA7-37-00-240		
PCEC-074-600V-230V	PCE-074-600V		CA7-43-00-240	PCV-147	TD296
PCEC-104-600V-230V	PCE-104-600V		CA7-60-00-240		TE296
PCEC-147-600V-230V	PCE-147-600V		CA7-85-00-240		TE296
PCEC-234-600V-230V	Complete Device	PCE-234-600V	CA6-180-EI-11-220W	PCV-234	CA6-TGE866
	Control Module	PCE-234			
	Power Pole	PCL-0135			



## Electrical

### Power Circuit

	UL/cUL/CSA	IEC
Rated Operational Voltage	200...600V AC	200...500V~
Rated Insulation Voltage	600V AC	500V~
Dielectric Withstand	2200V AC	2500V~
Repetitive Peak	200...600V AC: 1600	500V~: 1600
Rated Impulse Voltage	6 kV	
Over-voltage Category	III	
Number of Poles	Equipment designed for 3 phase only	
Operating Frequency	50/60 Hz	
Controller Utilization Category	32/51/64	AC-53b: 3.5-15:3585
	74/104/147	AC-53b: 4.5-30:1770
	234	AC-53b: 3.5-30:1770
Overload Current Range (Amps)	LINE	DELTA
32	6.3...19	10.9...32.9
51	10...30	17.3...51.9
64	12.3...37	21...64
74	14.3...43	25...74
104	20...60	84.6...104
147	28.3...85	50...147
234	34...135	59...234

### Control Circuit

	UL/cUL/CSA	IEC
Rated Operational Voltage	100...120 V AC, 200...240V AC	120~, 240~
Rated Insulation Voltage	NA	300V~
Dielectric Withstand	NA	3000V
Rated Impulse Voltage	3kV	
Operating Frequency	50/60 Hz	
Control Power Requirements	32/52/64	215 mA @ 120 V AC , 180 mA @ 240 V AC
	74/104/147	200 mA @ 120 V AC , 100 mA @ 240 V AC
	234	200 mA @ 120 V AC , 120 mA @ 240 V AC
Fan Power Requirements	32/52/64	NA
	74/104/147	NA
	234	20 VA

## Electrical (cont.)

### Short Circuit Capabilities

Short Circuit Performance	Type 1	
	Max Fuse Size and Type	Max Available Fault Rating
32	70 A - RK5	5 kA
	125 A - K5	5 kA
51	125 A - RK5	5 kA
	200 A - K5	10 kA
64	125 A - RK5	5 kA
	200 A - K5	10 kA
74	150 A - RK5	5 kA
	250 A - J	10 kA
104	200 A - RK5	5 kA
	400 A - J	10 kA
147	250 A - RK5	10 kA
	400 A - J	10 kA
234	400 A - RK5	10 kA
	450 A - K5	10 kA

### Auxiliary Contacts (Fault and Aux#1)

	UL/cUL/CSA	IEC
Rated Operational Voltage	250V AC / 30V DC	250V~ / 30V DC
Rated Insulation Voltage	250V	250V~
Rated Impulse Voltage	NA	4kV
Dielectric Withstand	1500V AC	2000V~
Operating Frequency	50/60 Hz	
Utilization Category	D300	AC-15 / DC
Type of Control Circuit	Electro-magnetic Relay	
Number of Contacts	1	
Type of contacts	Normally Open (N.O.)	
Type of current	AC/DC	
Rated Operational Current (Max.)	0.6 A @ 120 V~ and 0.3 A @ 240V~	
Conventional Thermal Current (I <sub>th</sub> )	1 Amp	
Make/Break VA	432/72	

## Mechanical

Resistance to Vibration	Operational	1.0 G Peak, 0.15 mm (0.006 in) displacement
	Non-operational	2.5 G Peak, 0.38 mm (0.015 in) displacement
Resistance to Shock	Operational	15 G
	Non-operational	5.5 G

## Environmental

Operating Temperature	0...50 C (32...122 F) Open
	0...40 C (32...104 F) Enclosed
Altitude	2000 m (6560 ft)
Humidity	5...95% (non-condensing)
Pollution Degree	2

# Motor Current Rating Chart

Horsepower	60 Hz AC Induction Motor						
	Single Phase		Three Phase				
	115 Volt	230 Volt	200 Volt	230 Volt	380-415 Volt	460 Volt	575 Volt
1/6	4.4	2.2	~	~		~	~
1/4	5.8	2.9	~	~		~	~
1/3	7.2	3.6	~	~		~	~
1/2	9.8	4.9	2.5	2.2	1.3	1.1	0.9
3/4	13.8	6.9	3.7	3.2	1.8	1.6	1.3
1	16.0	8.0	4.8	4.2	2.3	2.1	1.7
1 1/2	20.0	10.0	6.9	6.0	3.3	3.0	2.4
2	24.0	12.0	7.8	6.8	4.3	3.4	2.7
3	34.0	17.0	11.0	9.6	6.1	4.8	3.9
5	56.0	28.0	17.5	15.2	9.7	7.6	6.1
7 1/2	80.0	40.0	25.0	22.0	14.0	11.0	9.0
10	100	50.0	32.0	28.0	18.0	14.0	11.0
15	135	68.0	48.0	42.0	27.0	21.0	17.0
20	~	88.0	62.0	54.0	34.0	27.0	22.0
25	~	110	78.0	68.0	43.0	34.0	27.0
30	~	136	92.0	80.0	51.0	40.0	32.0
40	~	176	120	104	66.0	52.0	41.0
50	~	216	150	130	83.0	65.0	52.0
60	~	~	177	154	103	77.0	62.0
75	~	~	221	192	128	96.0	77.0
100	~	~	285	248	165	124	99.0
125	~	~	359	312	208	156	125
150	~	~	414	360	240	180	144
175	~	~	475	413	275	207	168
200	~	~	552	480	320	240	192
250	~	~	692	602	403	302	242
300	~	~	~	~	482	361	289
350	~	~	~	~	560	414	336
400	~	~	~	~	636	477	382
450	~	~	~	~	711	515	412
500	~	~	~	~	786	590	472

The information in this chart was derived from Table 430-148 & 430-150 of the NEC and Table 50.1 of UL standard 508A. The voltages listed are rated motor voltages. The currents listed shall be permitted for system voltage ranges of 110-120, 220-240, 380-415, 440-480 and 550-600 volts.

The full-load current values are for motors running at usual speeds and motors with normal torque characteristics. Motors built for especially

low speeds or high torques may have higher full-load currents, and multi-speed motors will have full-load currents varying with speed. In these cases, the nameplate current ratings shall be used.

**Caution: The actual motor amps may be higher or lower than the average values listed above. For more reliable motor protection, use the actual motor current as listed on the motor nameplate. Use this table as a guide only**

**sprecher+**  
**schuh**

**Divisional Headquarters**

Sprecher+Schuh US Division Headquarters  
15910 International Plaza Dr., Houston, TX 77032  
Customer Service: (877) 721-5913; Fax: (800) 739-7370

**[www.sprecherschuh.com](http://www.sprecherschuh.com)**

Publication No: MANUAL-PCEC-510 10/10  
[S+S P/N: 40055-252-01 (5) ]  
DIR 40055-252-01 (4)